

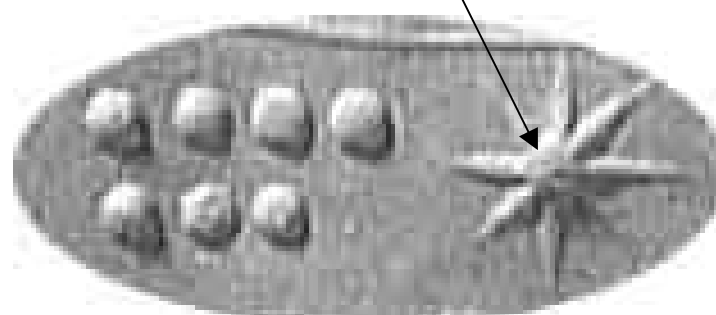

# Visitors to the Moon, final

## by Josef Kemény, 11/12/2014

The Moon is our nearest celestial body. What do we know about it? The astronomer talks about other planets similar to ours, but these celestial bodies exist in other solar systems, millions of light years away. The question whether there is life in space is still current. We are looking for life far from here, but what do we actually know about our solar system? Does life exist on other planets? Let us have a closer look at our solar system and our nearest neighbour the Moon. Note that I, in this context, use available material and I interpret it according to my knowledge.

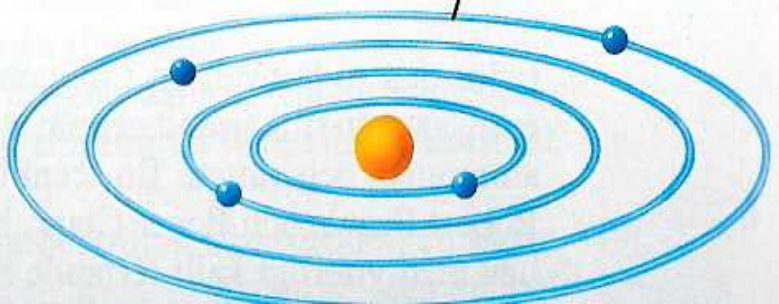
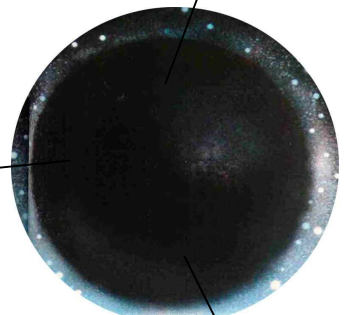
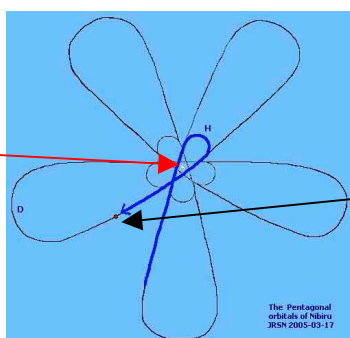
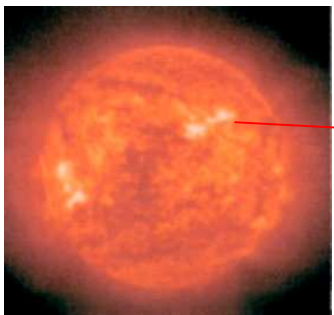
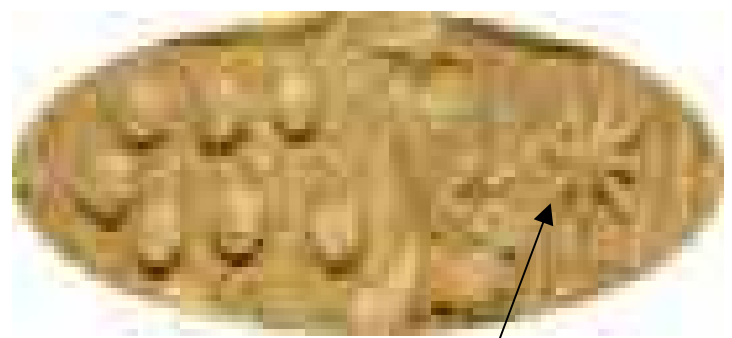
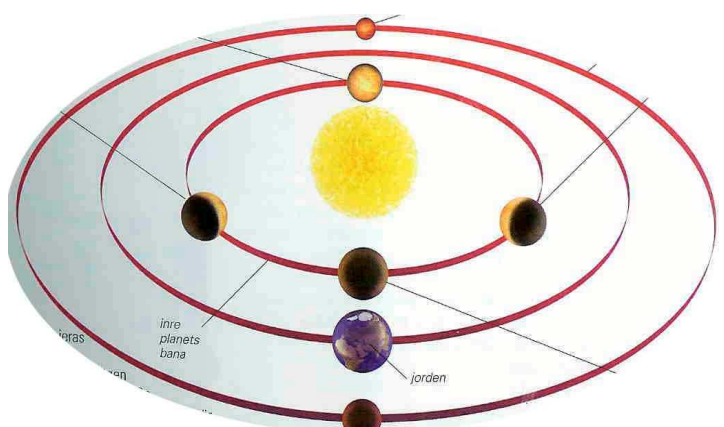

Our solar system, I, according to astronomers. It consists of nine planets, Pluto included. At the centre is the Sun, a proton star.

Our solar system, II, according to Sumerian astronomy. It has seven planets. At the centre is the neutron sun, a star. This picture is from the time of An.

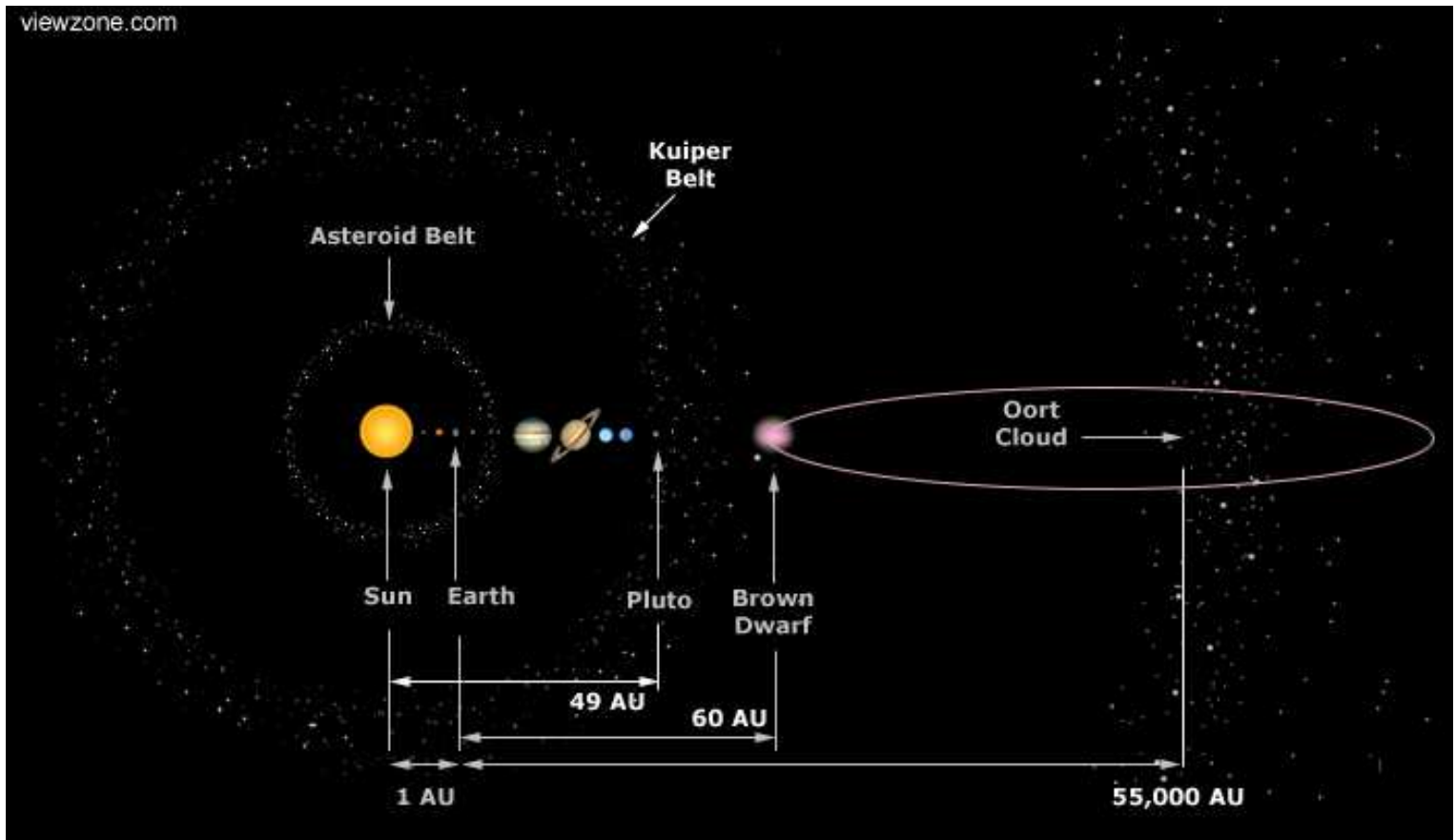

This is our solar system, a binary star system. More info at *The Maya Calendar and Omega*, pp 10-12.

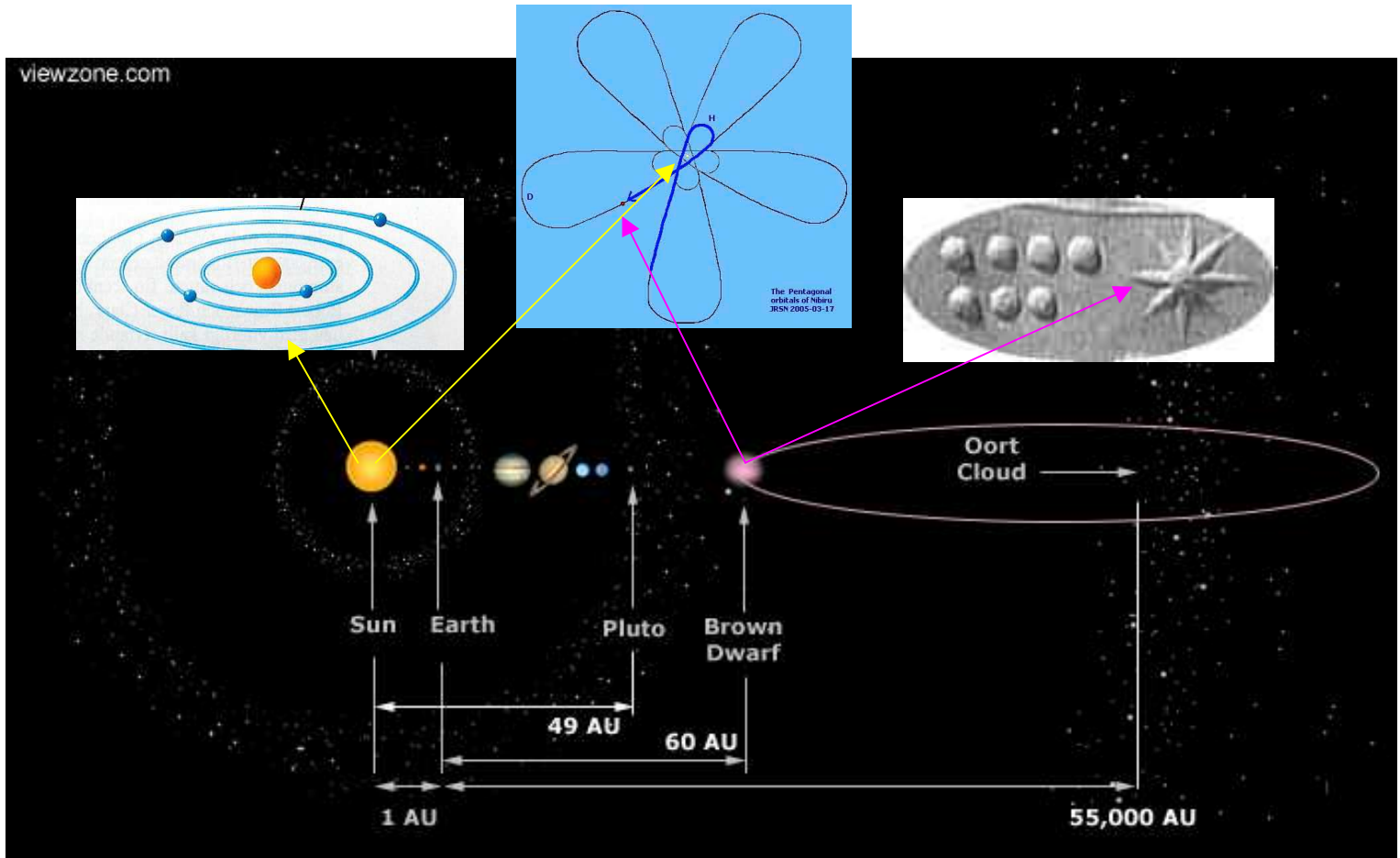

Above is our solar system with binary stars. The neutron star Nemesis has a pentagon orbit around the Sun, around 3,800 years. The Earth and the Moon, our nearest celestial body, exist in this binary star system.



Our nearest neighbour, the Moon, is a mystery. If we study ancient scriptures we do not find the Moon. They tell us about a small moon called **Azatlan**, orbiting the Earth. Azatlan was like a large asteroid with a diameter of some thousand kilometres. According to the records, this moon crashed on our planet and put out around 60-70 % of life on Earth, a terrible natural catastrophe. After this, life started to come back. Then the Moon (Luna) turned up for the first time, 10-12,000 years ago. After the Second World War, in the 1950's, the world's interest in the Moon grew. The USA/NASA and the Soviet Union/Roscosmos supported by Germans rounded up on the starting line for the Moon. More info at *Moon Mystery*, pp 95-101

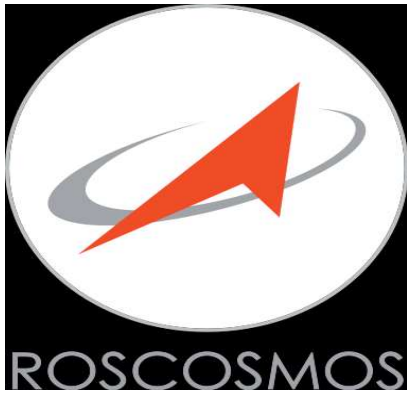

**The Soviet Union and its Vostok project, around 1955.**

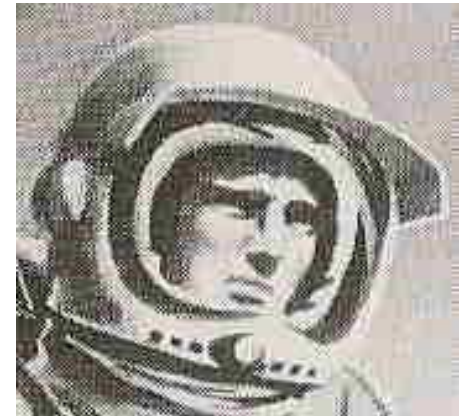
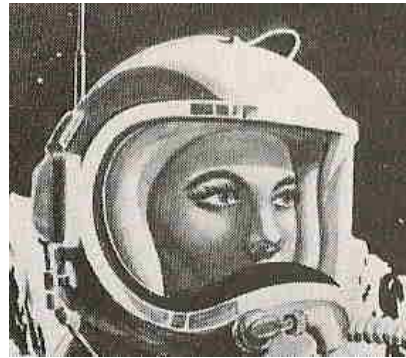

**Sergey Shiborin, Vostok 2**  
February 1958, Kapustin Yar

**Andrei Mitkov, Vostok 3**  
January 1959, Baikonur launch pad LC-1.

**Aleksei Ledovsky, Vostok 1** 1957, from Kapustin Yar.

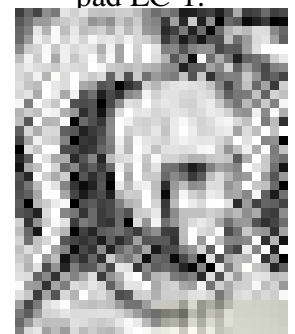

**Unknown, Vostok 5** 15 May 1960, Baikonur, launch pad LC-1



**Mirya Gromova, Vostok 4** December 1959, Baikonur launch pad LC-1. 1959. The first woman...



**Ivan Kachur, Vostok 6** 27 December 1960, Baikonur LC-1.



**Pyotr Dolgov, Vostok 7** 11 October 1960, Baikonur LC-1

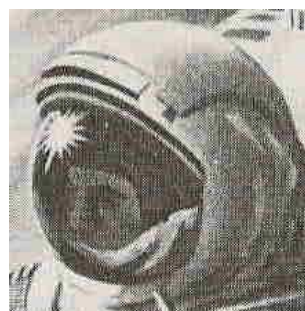

**Alexey Grachov, Vostok 8** December 1960, Baikonur, LC-1



**Gennady Zavadovsky, Vostok 9** End of December 1960, Baikonur LC-1



The secret list above shows the first nine Soviet cosmonauts. They all perished during their individual flights. This was the Soviet Union's secret start in the race for the Moon between NASA and Roscosmos. More info at *Moon Mystery*, pp 7-13.

# Man-In-Space-Soonest Project, NASA



## 25/06/1958

### NASA's first nine astronauts

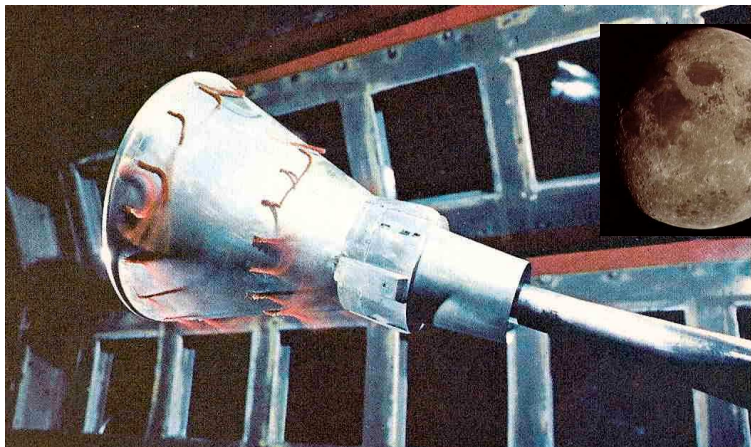

**Armstrong, Neil Alden**  
(1930-2012). USAF test pilot;  
Gemini 8, 1966, Apollo 11, The  
Eagle, lunar landing 1969, July 20



**Bridgeman, William Barton**  
(1916-1968)  
USAF test pilot



**Crossfield, Albert Scott**  
(1921-2006)  
USAF test pilot



**Kincheloe, Iven Carl**  
(1928-1958)  
USAF test pilot

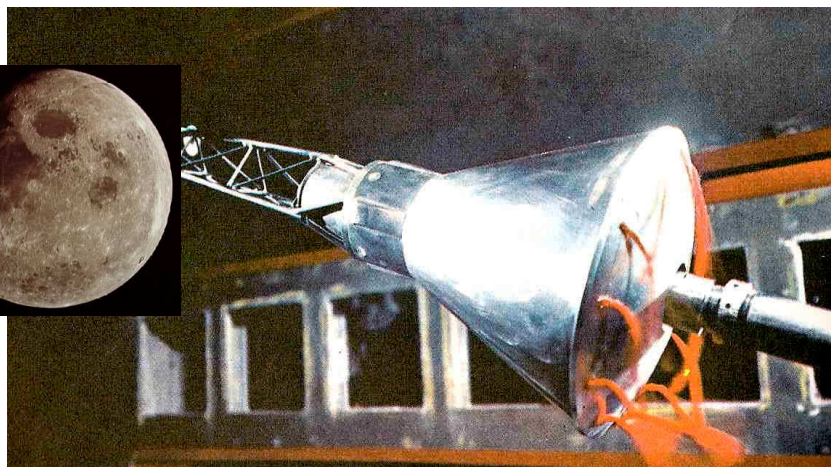

**McKay, John Barron**  
(1922-1975)  
USAF test pilot



**Rushworth, Robert Aitken**  
(1924-1993)  
USAF test pilot



**Walker, Joseph Albert**  
(1921-1966)  
USAF test pilot



**White, Alvin Swauger**  
(1918-2006)  
USAF test pilot



**White, Robert Michael**  
(1924-2010)  
USAF test pilot



Man-In-Space-Soonest. In 1958, on June 25, NASA for the first time introduced a preliminary list of the first nine astronauts for manned flights around the Earth. According to reports they were all carefully selected high-quality test pilots. The next introduction took place in 1959.

# Project Mercury, the first step towards the Moon.

09/04/1959

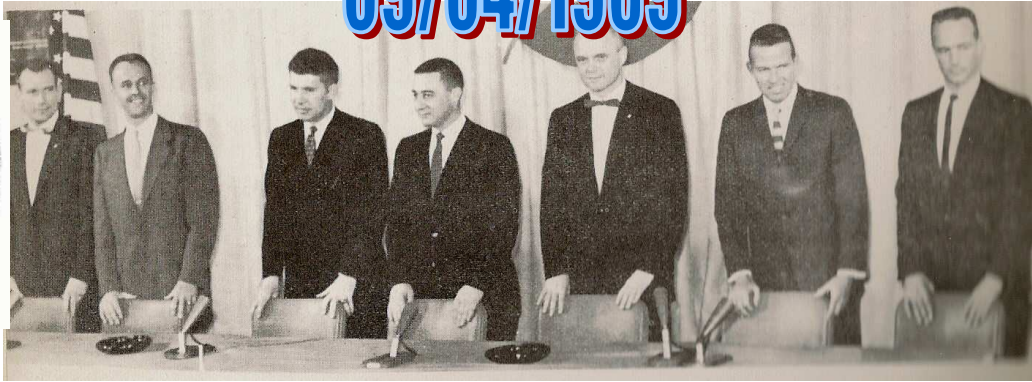

Donald K. Slayton, Alan B. Shepard, Walter M. Schirra, JR, Virgil I. Grissom, John H. Glenn, L. Gordon Cooper, Malcolm S. Carpenter



The Soviet lunar projects Vostok, Voskhod and Soyuz in the 1950's, 60's and 70's. The foundation of these projects consisted of Germans who had left Germany in 1945 to work for the Soviet Union. More info at *Moon Mystery*.



USA's lunar projects Mercury, Gemini and Apollo in the 1950's, 60's and 70's. Again, the foundation was German, e.g. Werner von Braun, who had left Germany in 1945 and chosen the USA as his next home. More info at *Moon Mystery*.

We know that the Americans have landed on the Moon but we also know they had to abort. **Apollo 18, Apollo 19 and Apollo 20** never got under way. According to the earlier, secret list, the Russians have orbited the Moon once, in 1968. This was their first and last manned trip around the Moon. Manned lunar voyages do not occur at present. More info at *Moon Mystery*, pp 43-46, 57-87, and 95-102

The third great space nation is China, which lags behind the USA and Russia with about 15 to 20 years, but "The Red Dragon" seems to be successful with their space programme.



# DRAGON IN SPACE



China, the third great space nation, via their Shenzhou project, is planning the flight to our nearest neighbour in space.



CNSA, China National Space Administration, was founded on 22 April, 1993



**Yang Liwei**



**China's first ten taikonauts 2003-2013, Project Shenzhou**



**Fei Junlong**



**Nie Haisheng**  
Two spaceflights



**Jing Haipen**  
Two spaceflights



**Liu Buoming**



**Zhai Zhigang**



**Liu Wang**



**Liu Yang**

The Chinese taikonauts are prepared for a lunar voyage connected to the Shenzhou project. China could be the next visitor to the Moon, but their priority is Shenzhou.





**Shenzhou-5**



**Shenzhou 5**  
15/10/2003

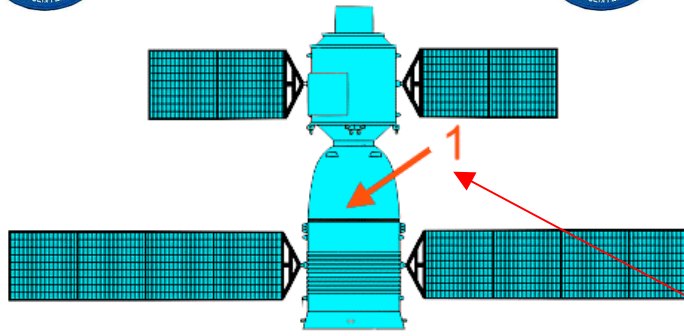

**Taikonaut Yang Liwei**

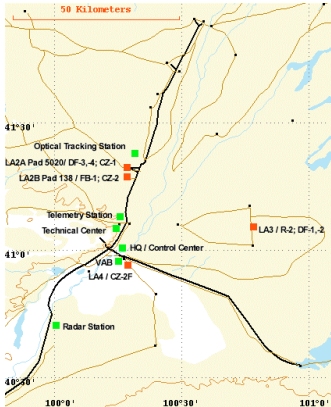

**Launch pad: 1**

Shenzhou 5 takes off on 15 October, 2003 from the Jiuquan launch pad LA-4/SLS-1

The Shenzhou 5 crew on their way to the launch pad



Shenzhou 5 orbits the Earth, 200 - 343 kilometres



Shenzhou 5 touches down in Mongolia, on 15 October, 2003, China's first manned spaceflight, successfully carried out compared to Vostok 1, 1957, and Mercury 3, 1961.



**Shenzhou 6**



**Shenzhou 6**  
12/10/2005

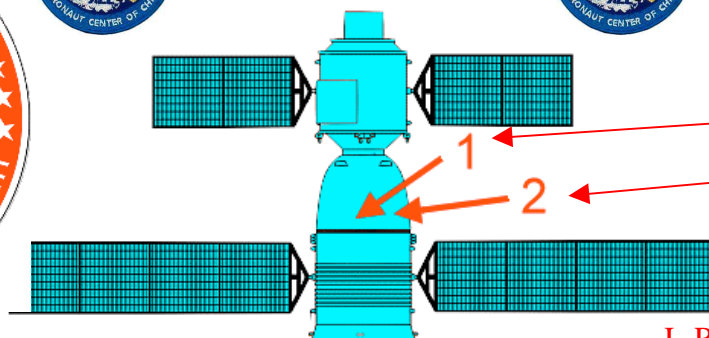

L-R: Fèi Jùnlóng (1) commander, Niè Hǎishèng (2), Operator





## Launch pad: 1

Take-off on 12 October 2005, Shenzhou 6  
From the Jiuquan launch pad LA-4/SLS-1

The Shenzhou 6 crew on  
their way to the launch pad.



Shenzhou 6 touch-down in Mongolia on 16 October, 2005, China's second successful spaceflight. The flight took four days, then the retro rockets started.



## Shenzhou 7

## Shenzhou 7

25/09/2008

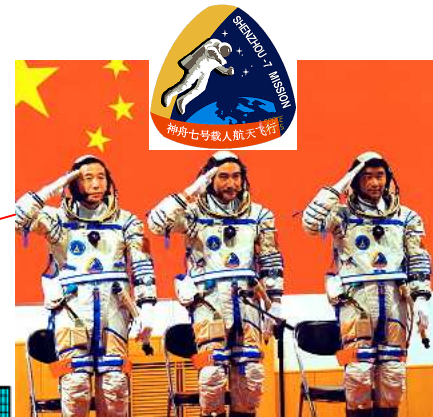
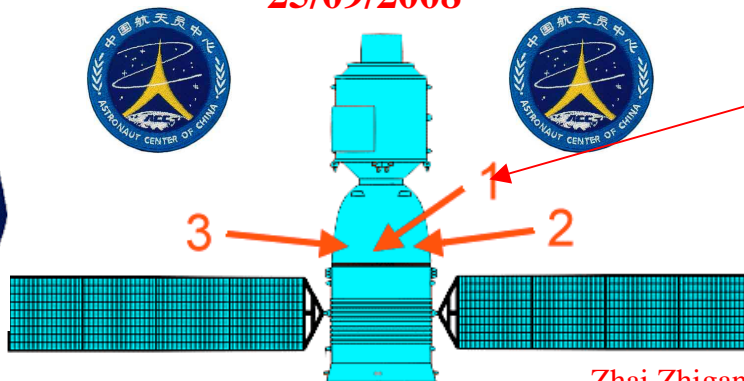

Zhai Zhigang (1) commander, Liu Boming (3), Jing Haipen (2),

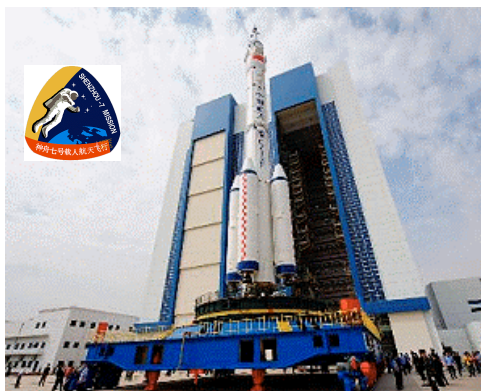

Shenzhou 7 takes off on 25 September 2008,  
Jiuquan launch pad LA-4/SLS-1

The Shenzhou 7 crew on their way to  
Jiuquan LA-4/SLS-1 launch pad.





Shenzhou 7 orbits the Earth, 330-340 kilometres

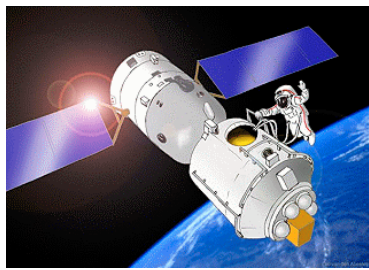

The first Chinese spacewalk, taikonaut Zhai

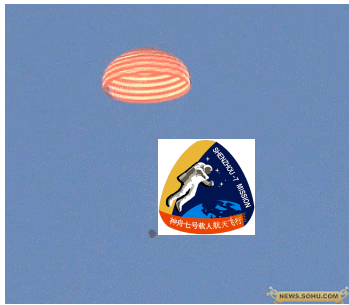

Shenzhou 7 landed in Mongolia in the morning of September 28, 2008. This was China's third successful manned spaceflight, this time including a spacewalk. The flight lasted for three days around the Earth before Shenzhou 7 aided by retrorockets touched down in Mongolia.



Shenzhou 8



Shenzhou 8  
31/10/2011

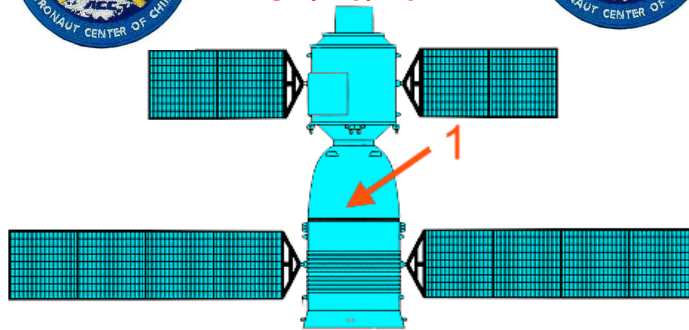

Taikonaut/dummy



On September 29, 2011, space station Tiangong 1 took off. Thereafter Shenzhou 8 took off from the Jiuquan launch pad LA-4/SLS-1

The Shenzhou 8 crew (the dummy) on its way to the launch pad.





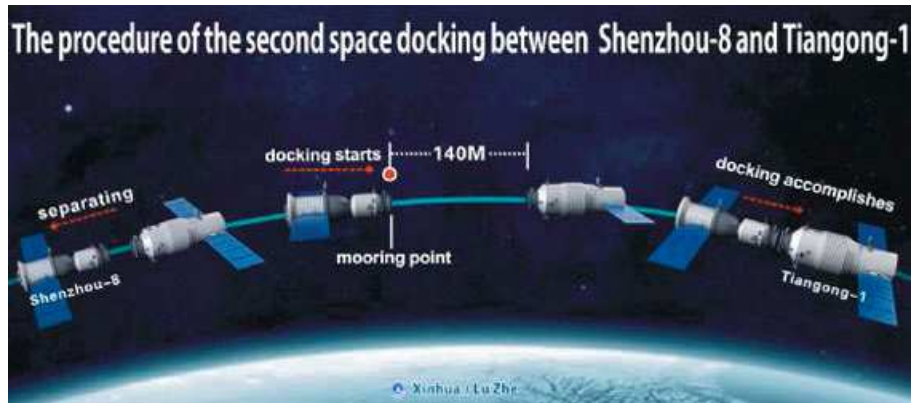

The pictures illustrate the docking between the spaceship Shenzhou 8 and the laboratory Tiangong 1.

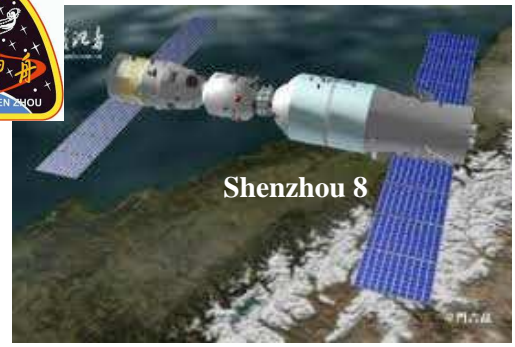
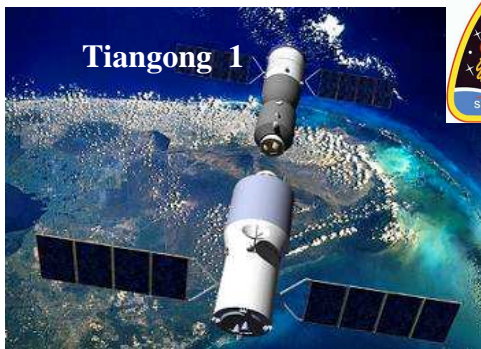

Shenzhou 8 and Tiangong 1. The docking took place between November 3 and 4, 2011

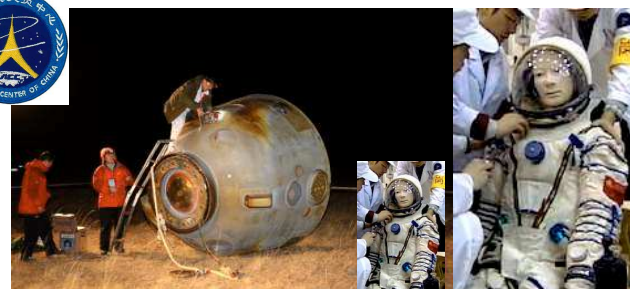
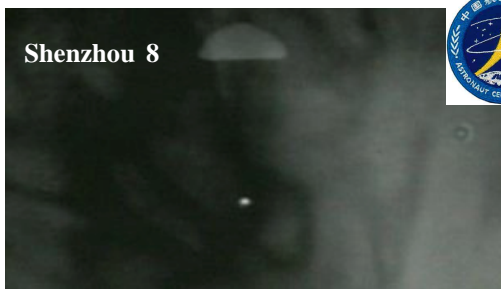

Shenzhou 8 landed on November 17, 2011, in Mongolia after a successful docking programme. Shenzhou 8 orbited the Earth during 17 days. China also launched a space station which now orbits the Earth.

## Shenzhou 9

16/06/2012

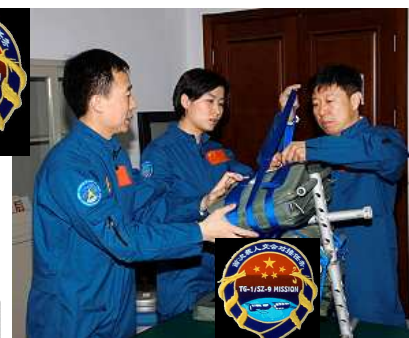
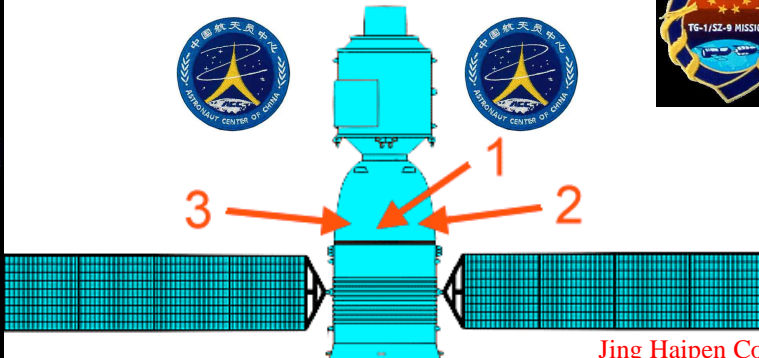

Jing Haipen Commander (1), Liu Wang Operator (3), Liu Yang Operator (2).

## Shenzhou 9



Shenzhou 9 took off from Jiuquan LA-4/SLS-1 on June 16, 2012,







Tiangong 1



Shenzhou 9

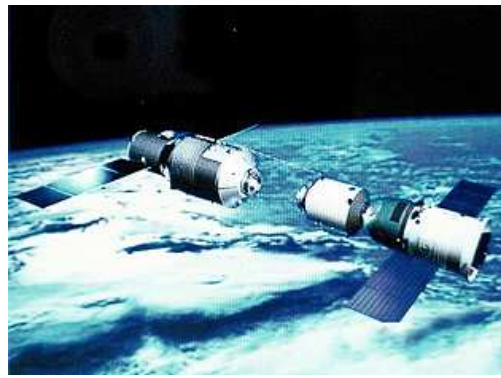

Tiangong 1

Shenzhou 9



Docking: spaceship Shenzhou 9 space station Tiangong 1, June 18.



On board space station Tiangong 1



The Shenzhou 9 crew touched down in Mongolia at night on June 29, 2012 after a successful program with a 13-day orbit. For the first time, taikonauts were on board a Chinese space station during ten days.

# Shenzhou 10

11/06/2013

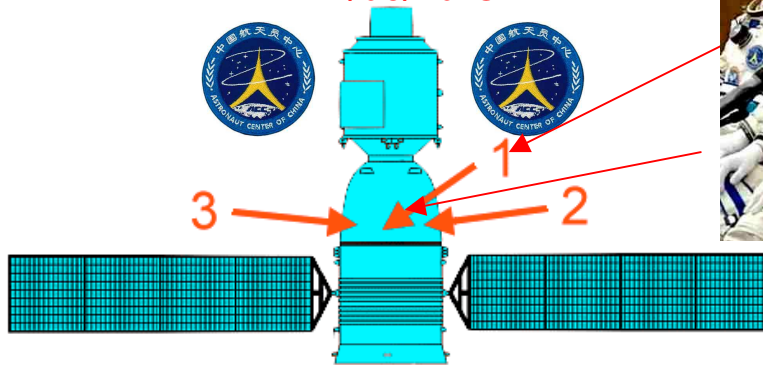

Nie Haisheng Commander (1), Zhang Xiaoguan Operator (2) Wang Yaping Operator (3)

## Shenzhou 10







Shenzhou 10 took off from launch pad Jiuquan LA-4/SLS-1 on June 11, 2013.

The Shenzhou 10 crew on its way to the launch pad.

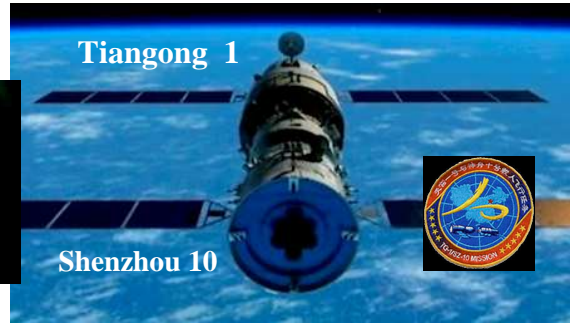
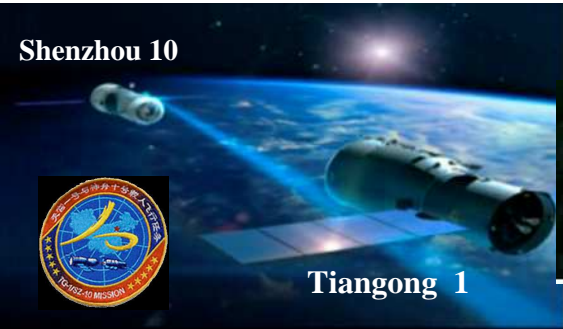

Shenzhou 10

Tiangong 1

Tiangong 1

Tiangong 1

Shenzhou 10

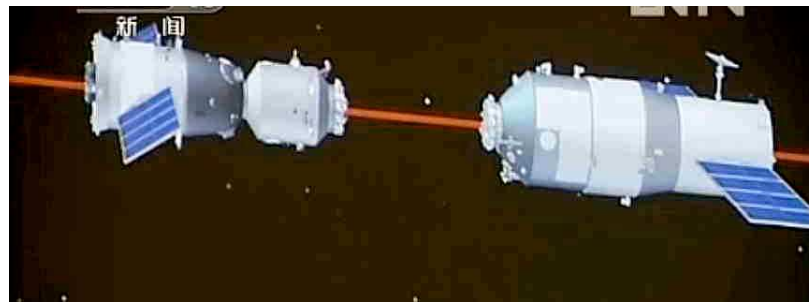

Docking between Shenzhou 10 and space station Tianhngong 1 on June 13, 2013.

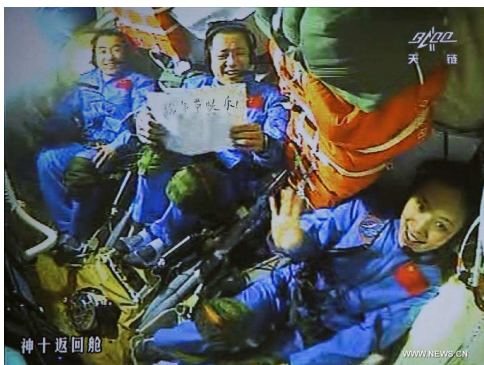

On board Shenzhou 10

On board space station Tiangong 1.

The taikonauts feel at home up there



Space station occupations

Separation between spaceship Shenzhou 10 and space station Tiangong 1 on June 24, 2013.



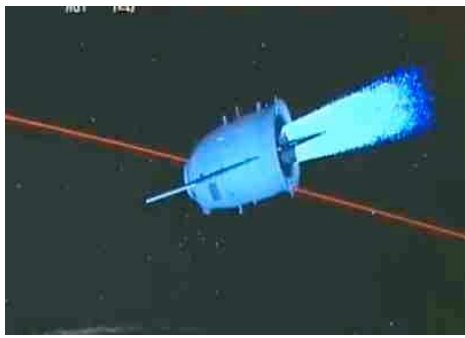

The retro rockets work well and the capsule falls into the right angle to return to Earth. The crew is clearly visible during the descent.

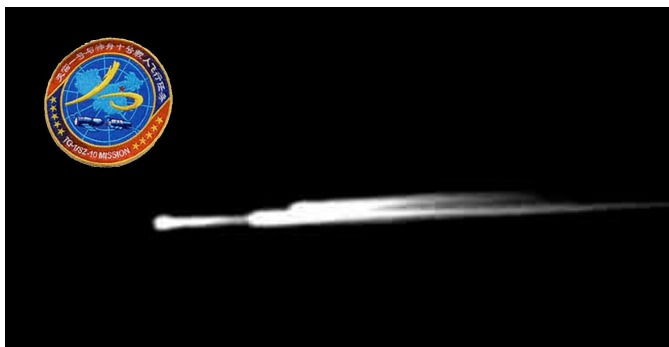

The capsule reminds us of a comet through the atmosphere when it approaches the Earth.



On June 26 2013, in the middle of the night, Shenzhou 10 touched down in Mongolia after having orbited the Earth during 17 days. The crew had spent nine days inside the space station. I think that, in the 1990's, the Russians initially helped China to start the Shenzhou project, since it is very similar, structurally, to Soyuz.

The Moon, together with the Shenzhou project, are the two main objectives for CNSA. The first lunar probe was launched in 2007. The Chang'e lunar probes are named after the Chinese Moon Deity Chang'e.

## Chang'e 1, 10/24/2007

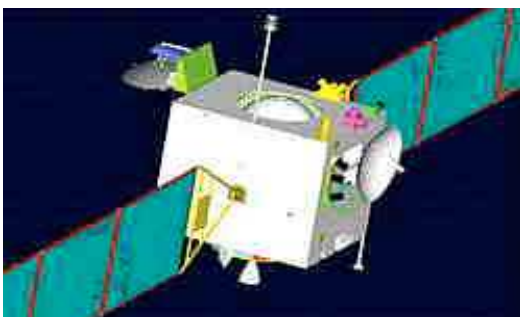
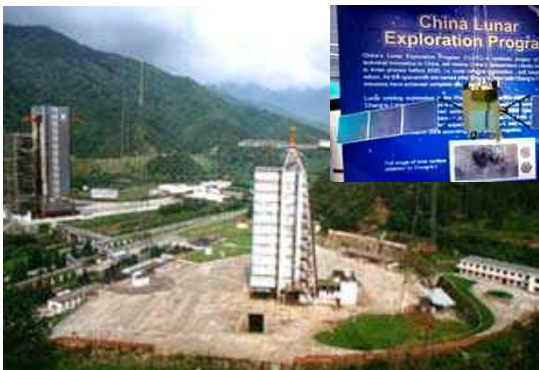

On October 24, 2007, the lunar probe **Chang'e** was launched from Xichang Satellite Launch Center, Launch Pad 3, without problem. China's first lunar satellite left the launch pad and was directed towards the Moon. China had joined a lunar programme after the USA and Russia.

China plans to carry out manned trips to the Moon as well as Moon landings.



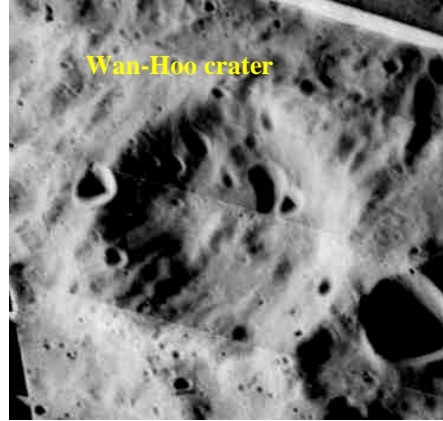
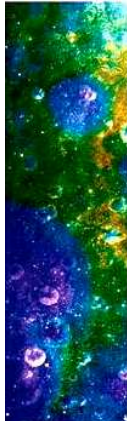
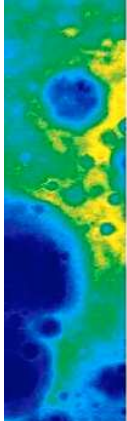
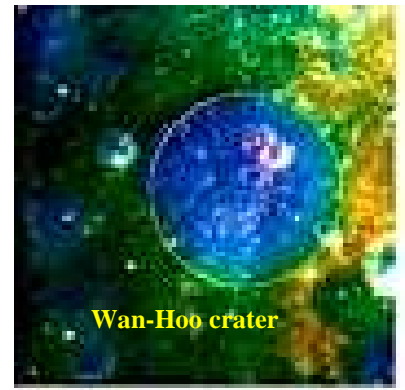
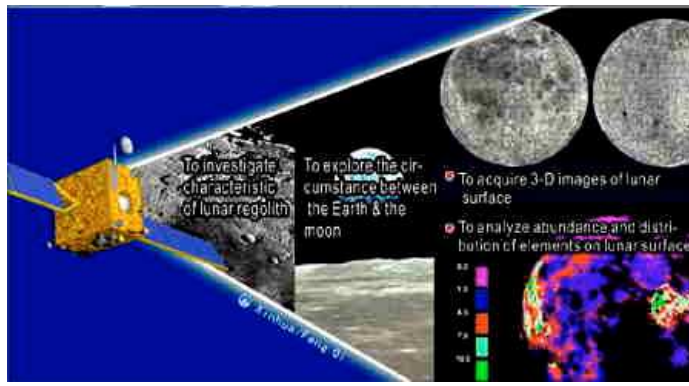

Chang'e 1 entered an orbit around the Moon on November 5, 2007. The first pictures of the Moon were transmitted on November 26, 2007 pictures of the Wan-Hoo crater, see above. Its diameter is 52 kilometres. The crater was named after Wan-Hu and is on the reverse side of the Moon.

From the colour pictures we can see that it has green plants, despite the fact that it is on the reverse side of the Moon. The blue colour looks like the sea.

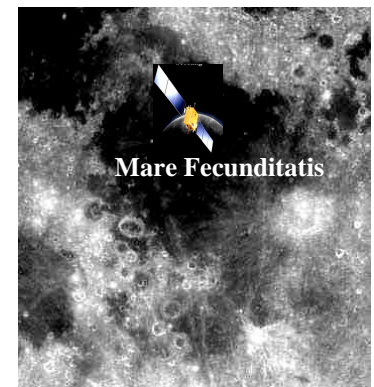
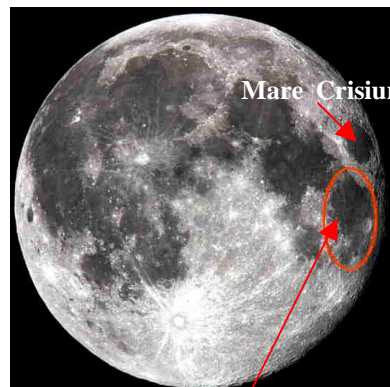

Chang'e 1 crashes...

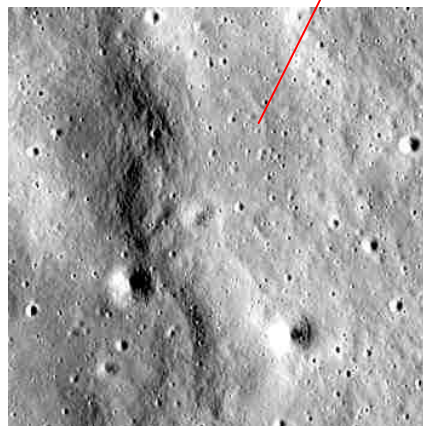
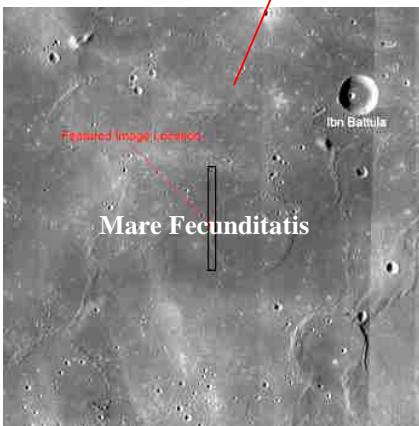

Mare Fecunditatis (Sea of Fecundity), with a diameter of 909 kilometres. The lunar probe took many colour pictures of the Moon before it crashed on March 1, 2009, in Mare Fecunditatis, which is south of Mare Crisium. Mare Fecunditatis and Mare Crisium are both situated between the front and reverse parts of the Moon, a special area. The mission was planned to last a year but was prolonged and went on to March 1, 2009. I will come back to Mare Crisium later, a very interesting issue. We can add that **Luna 16** touched down at Mare Fecunditatis on September 20, 1970. The day after the lunar probe took off, returned to Earth and landed 80 kilometres south-west of Dzhezhkazan. **Luna 20** carried out the same landing in Mare Fecunditatis/Appolonius Highlands two years later, on February 21, 1972. It returned to Earth on February 22 and landed on February 25, 1972 40 kilometres north-west of Dzhezhkazan.)



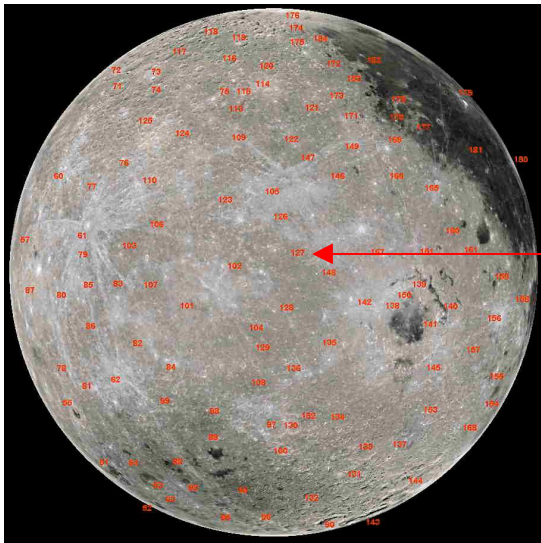
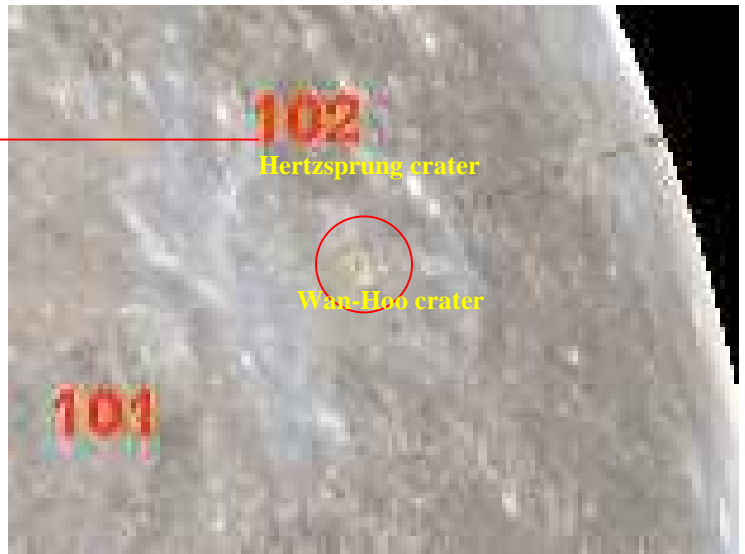
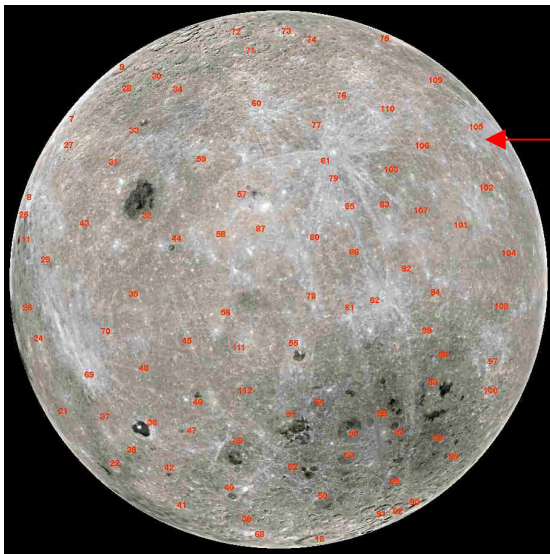

The Wan-Hoo crater is on the far side of the Moon, south-west of the Hertzprung crater which has a diameter of 591 kilometres. Maybe a suitable landing site for the Chinese, the taikonauts.

## Chang'e 2, 01/10/2010

Xichang Satellite  
Launch Center

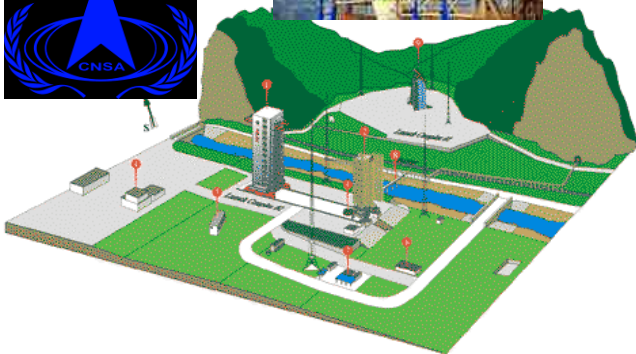

Lunar probe Chang'e 2, China's second lunar satellite, took off from Xichang Satellite Launch Center on October 1, 2010. Its purpose is to prepare the Chang'e 3 landing at "Sinus Iridum" at the front face of the Moon.



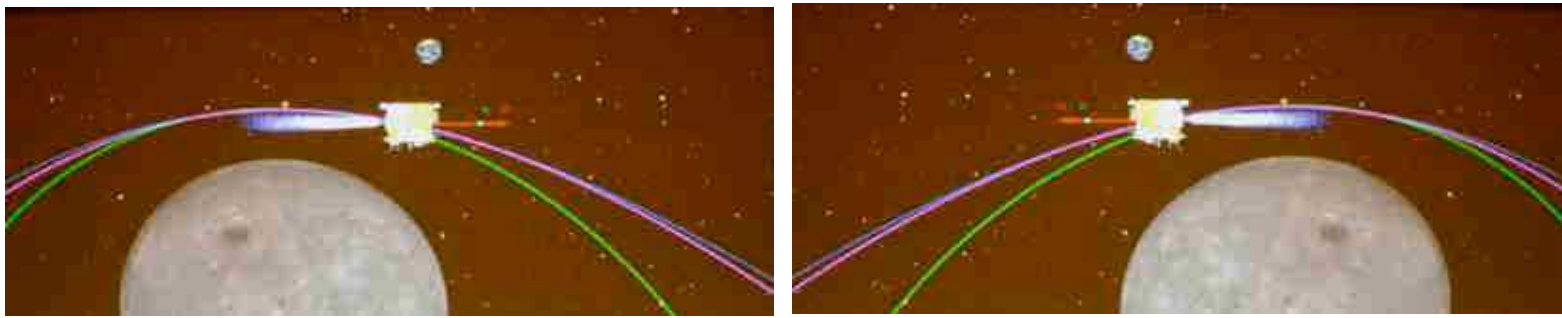

The lunar probe Chang'e 2 orbits the Moon, altitude 100 kilometres

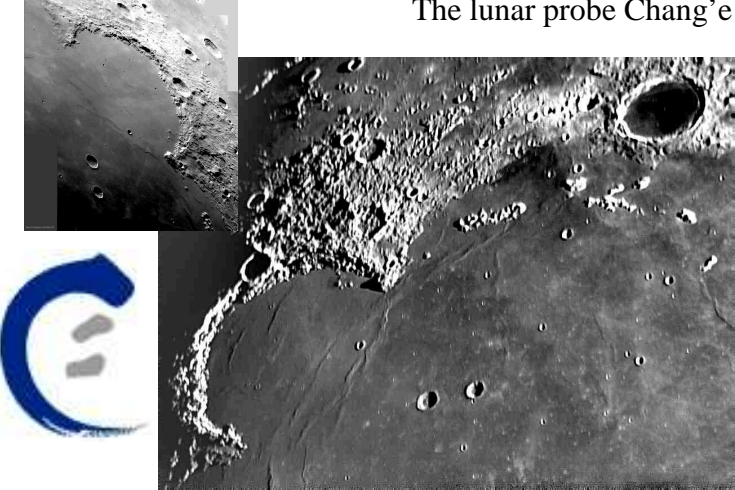

Pictures of Sinus Iridum, taken by the lunar probe. According to plans, Chang'e 3 will touch down here at the end of 2013.

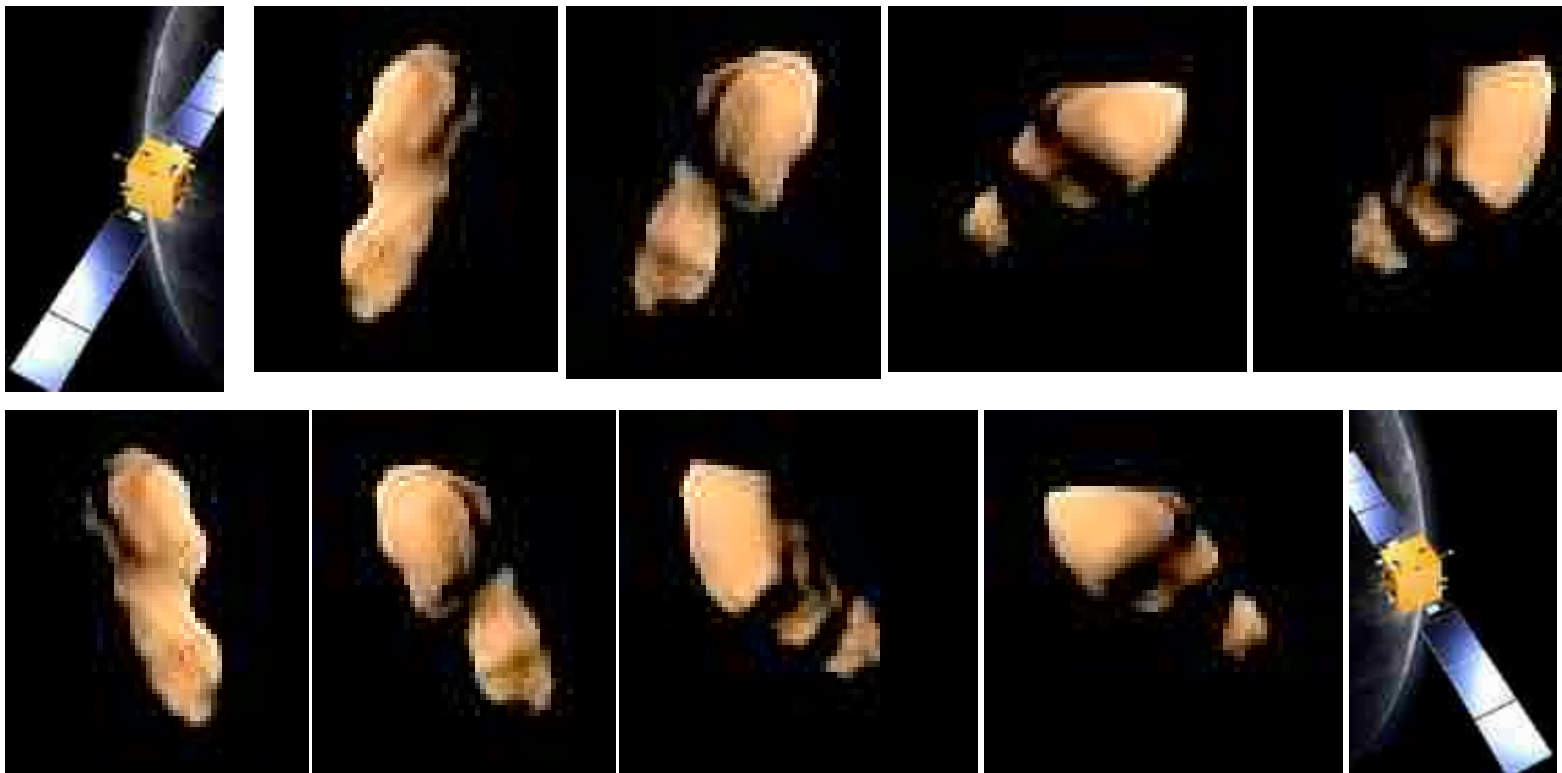

Chang'e 2's original trajectory was changed and on August 25, 2011 it arrived at the so-called L2 Lagrangian point, 1.5 million kilometres from the Earth. On December 13, 2012, it was only 3.2 kilometres from the small asteroid 4179 Toutatis and took these pictures. The asteroid has a length of 4.8 kilometres.

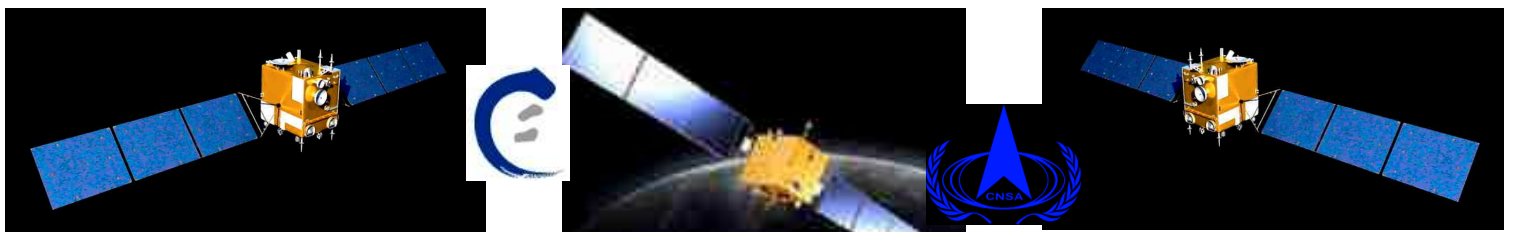

In 2014 Chang'e 2 is expected to be 100 million kilometres from the Earth.



# Chang'e 3, --14/12/2013

Landing at Sinus Iridum.

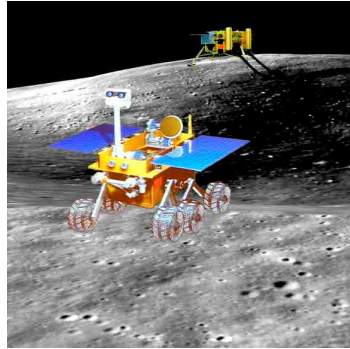
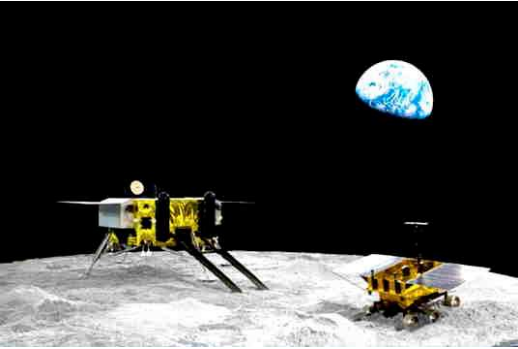
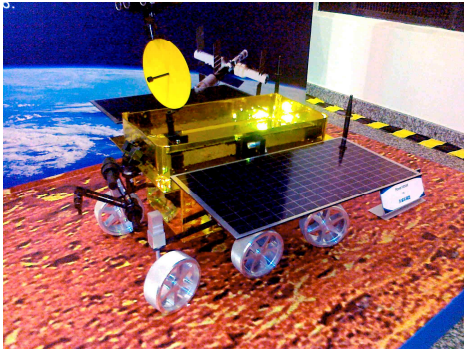

If we sum up China's space programme and its execution from 1993 and compare it to the programmes of the USA and Russia, we notice that China underlines safety, precision and security. China does not like racing (the Russians do and everything they did in those days failed, except the lunar probe Luna 3). The Soviet Union was not fit enough for the great race to the Moon, a race the USA dominated at the beginning. There is no fourth space nation to challenge China, what CNSA has achieved so far is well thought-through and carried out. The only race going on today is against time connected to the natural catastrophes, phenomena familiar to the US and Russia.

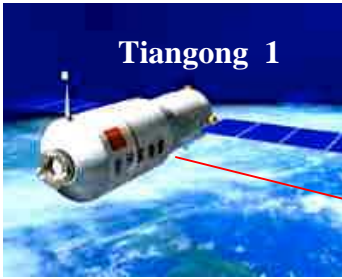

Tiangong 1

China

Now China has its own space station, a large eye directed towards outer space. Now the CNSA can carefully observe the trajectory of the neutron star past the Sun and study the origins and results of the natural catastrophes.

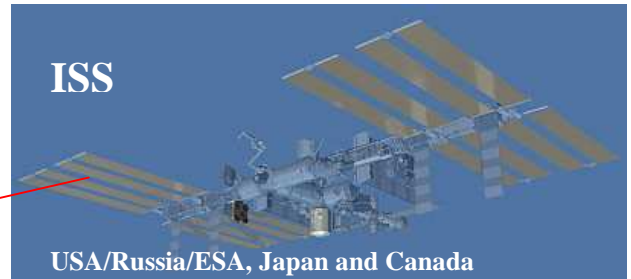
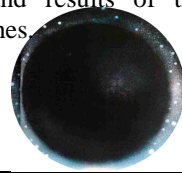

ISS

USA/Russia/ESA, Japan and Canada

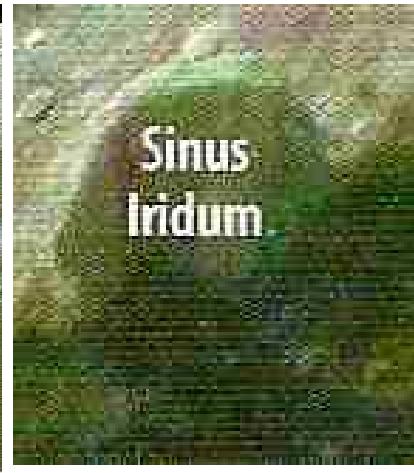
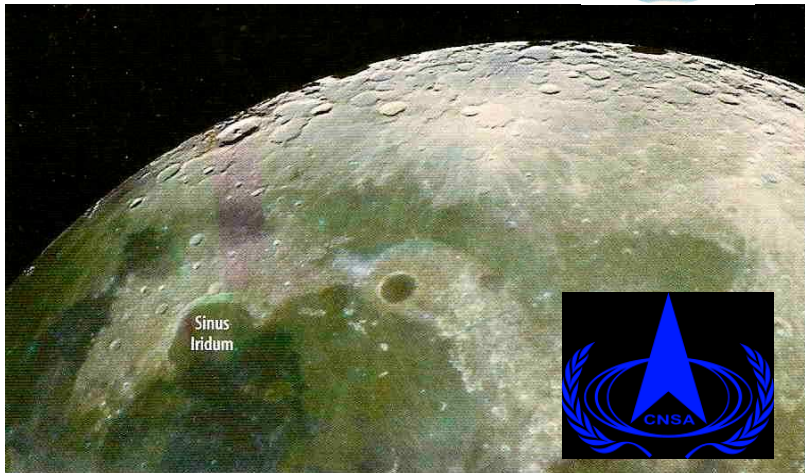

Sinus Iridum is a flat, excellent landing area in which the Chinese take much interest. China is exploring the area and will soon carry out a manned space flight and moon landing. Apollo 15 (Falcon) landed close to Sinus Iridum, at Monte Apenninus, on July 30, 1971. Some information maintains that there is a large moon base at Sinus Iridum.





The mother ship

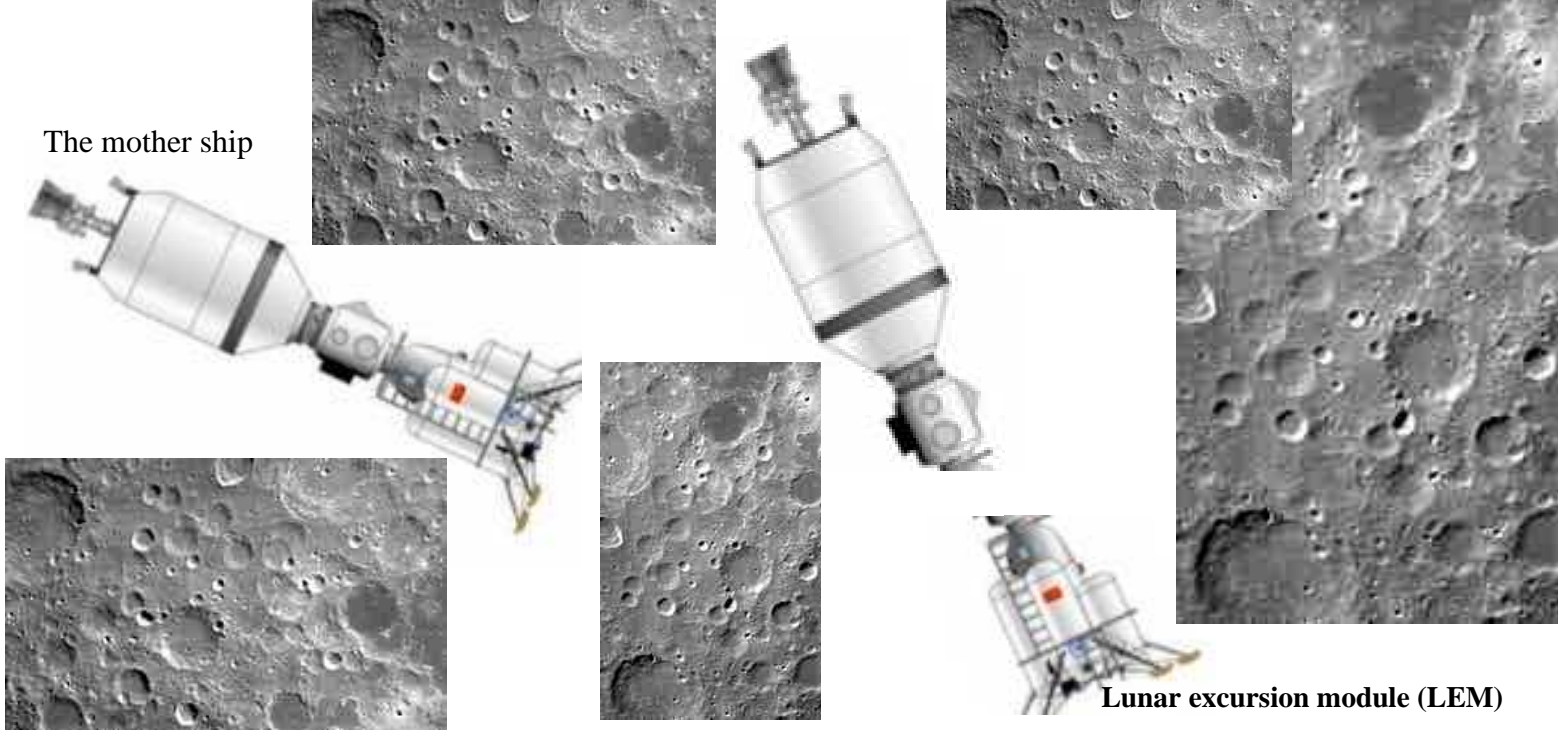

Lunar excursion module (LEM)

The flight and the landing will be similar to those of APOLLO'S: the LEM parts from the mother ship and lands on the Moon, the mother ship remains in orbit.

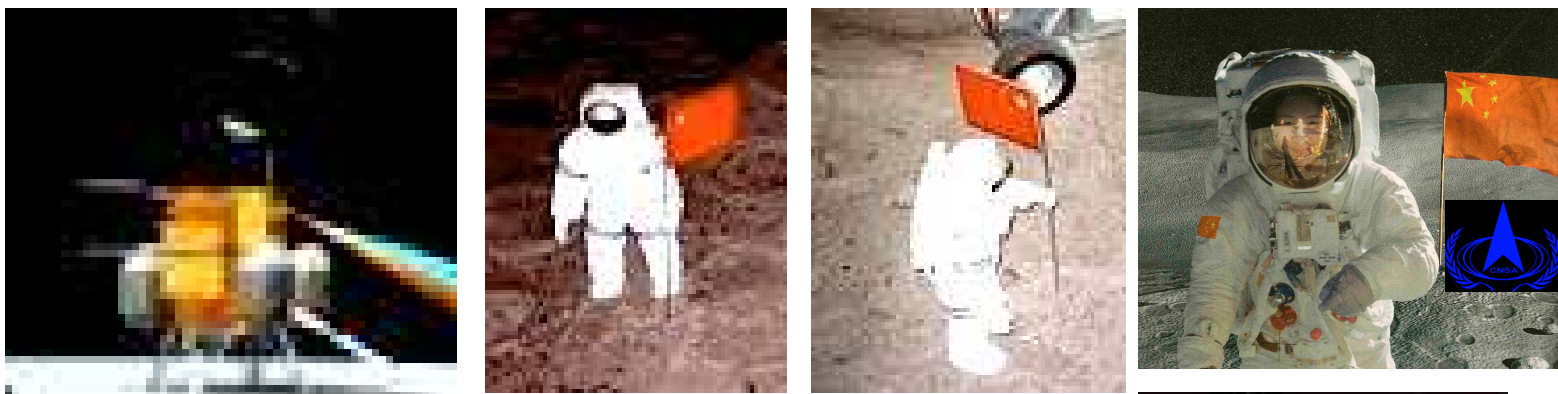

Landing on the Moon

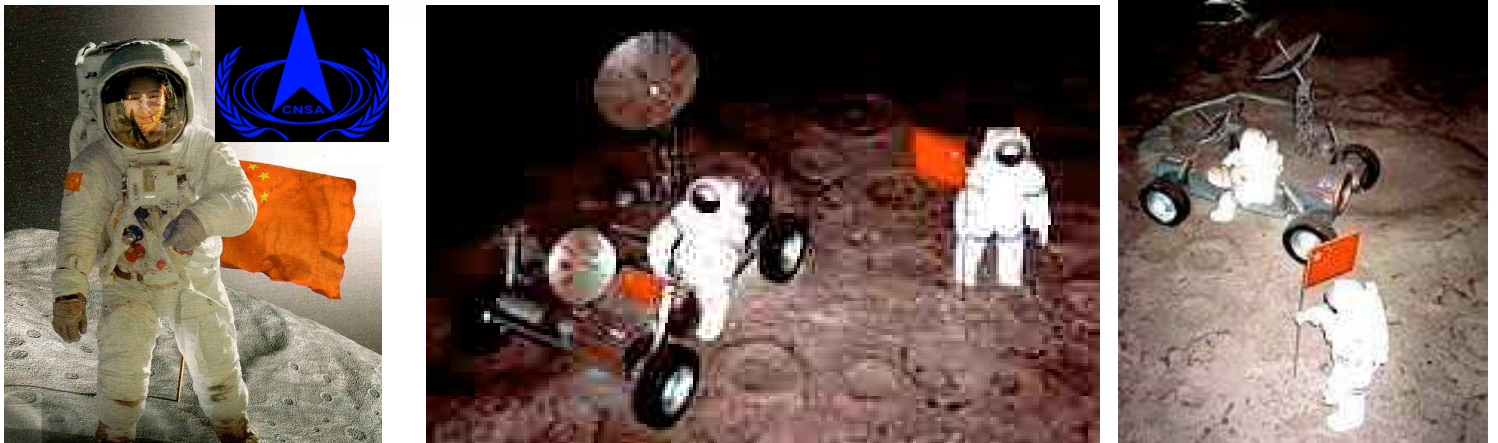

The Earth, seen from Sinus Iridum





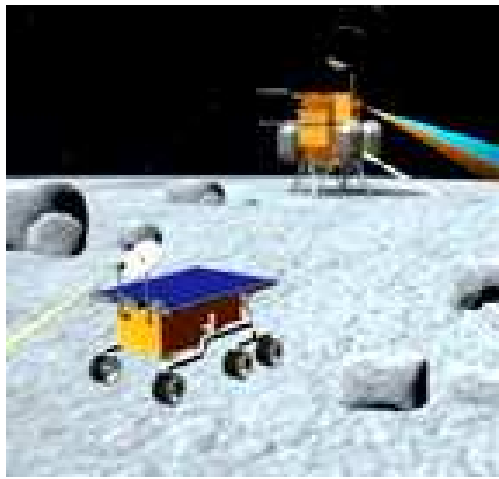
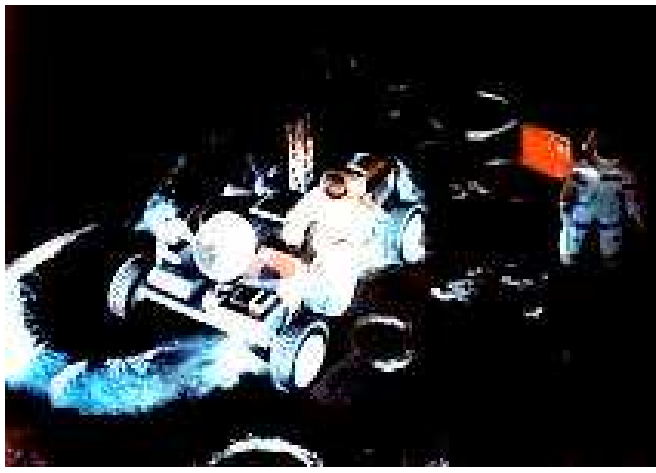

Start with a half LEM from the Moon.

**2030** may be the year when China/The Dragon will be the next nation to land on the Moon, 61 years after the American Neil Armstrong, the first "Earthling" on the Moon. The pictures above illustrate a possible first visit to the Moon by the Chinese.

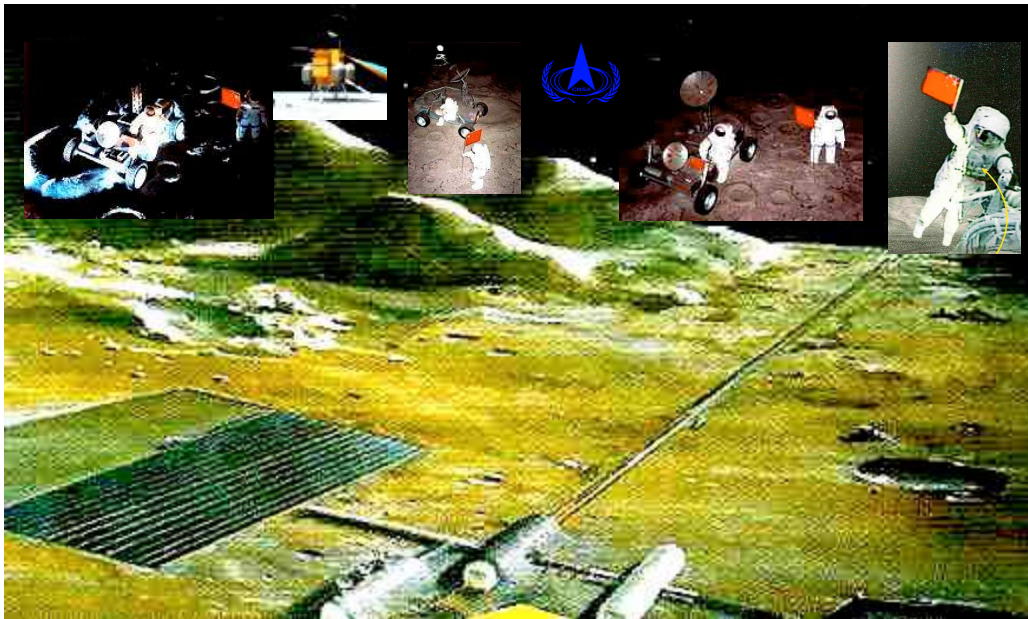

After 60 years there is a renewed interest in voyaging to the Moon. The Americans have gathered hundreds of kilos of rocks from the Moon, from different areas and for different types of research, e.g. to establish the age and origin of the Moon. But something has happened, the promised results regarding the origin of the Moon have not been published. I cannot remember that NASA and other scientific institutions during all these years have confirmed that the Moon and the Earth are of the same origin. This may mean that the origin of the planets is not the same, i.e. the Moon is older than the Earth. But from where did the Moon come, since it does not appear in the old records? Around 50 % of the rocks gathered by the astronauts have disappeared.

According to science, the solar system is 4.5 billion years old.

The planets were formed during 50 million years.

The rocks gathered from the Moon were formed later, 3.8-4.1 billion years ago, according to scientists.

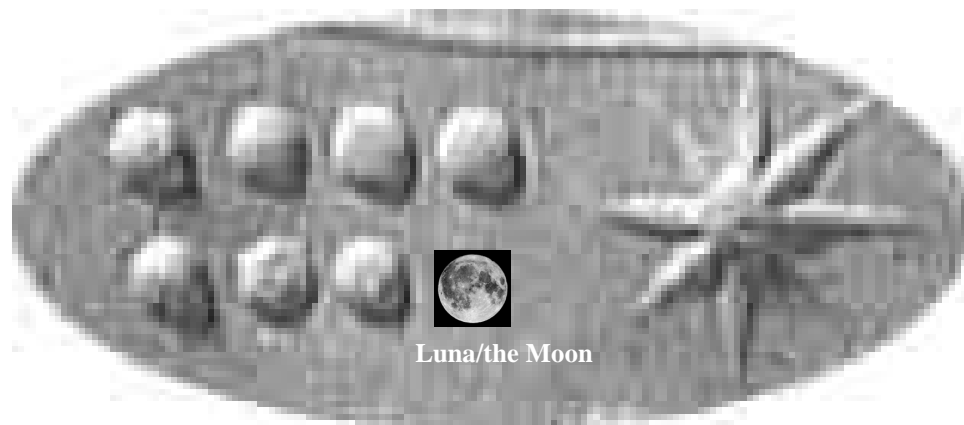

Luna/the Moon

So there is no proof that the Earth and the Moon were formed at the same time, or that the Moon was part of the Earth.

Neutron star AN/Aton/Nemesis is called the Sun's twin sister, I do not know why. Anyway, the Moon has come from from Nemesis's solar system which is already in our solar system, soon orbiting the Sun. It earlier came loose from the neutron star and ended up around our planet. The Moon would have made the eighth planet in Nemesis's solar system. More info at *Life and the Black Hole*, pp 6-7.



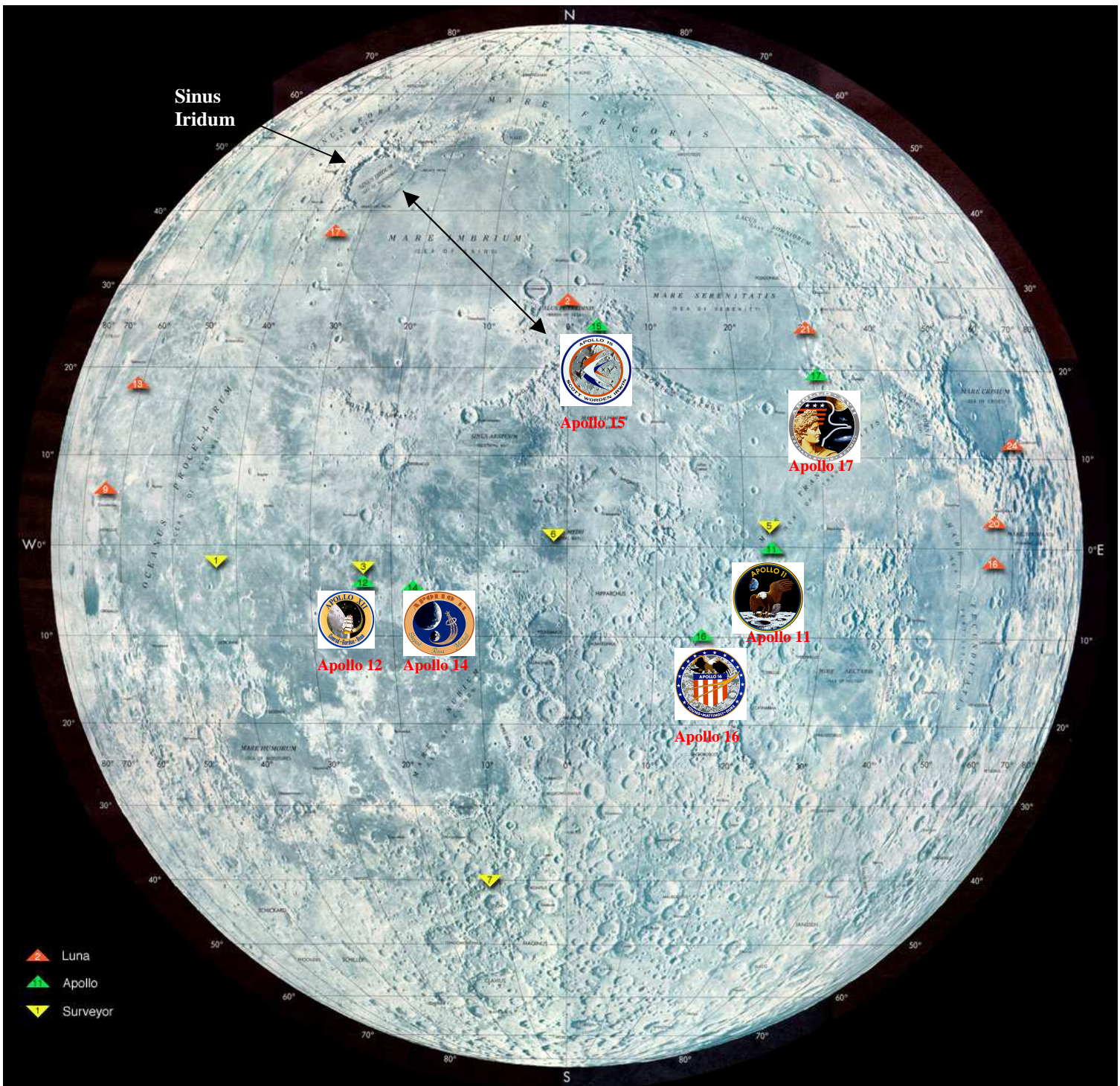

All six Apollo landings at our nearest celestial body, the Moon. The red triangles pinpoint the Russian Luna landings, the yellow ones refer to the American Surveyor. We can clearly see that the landing site of Apollo 15 is closest to Sinus Iridum, where the Chinese were supposed to land. More info at *Moon Mystery*, pp 47-83. Let us first have a close look at the three landing areas where the Americans were not allowed to touch down: **Copernicus crater, Hyginus Rille och Tycho crater.**



Copernicus crater

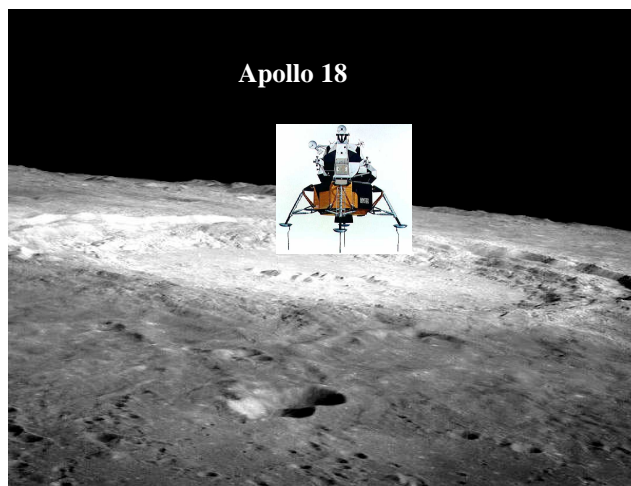

Apollo 18



Copernicus crater



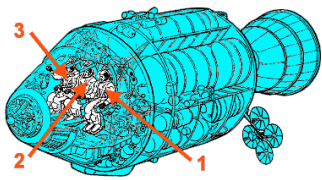

# Apollo 18, 07/01/1973



Brand, Vance



# 18

Copernicus crater

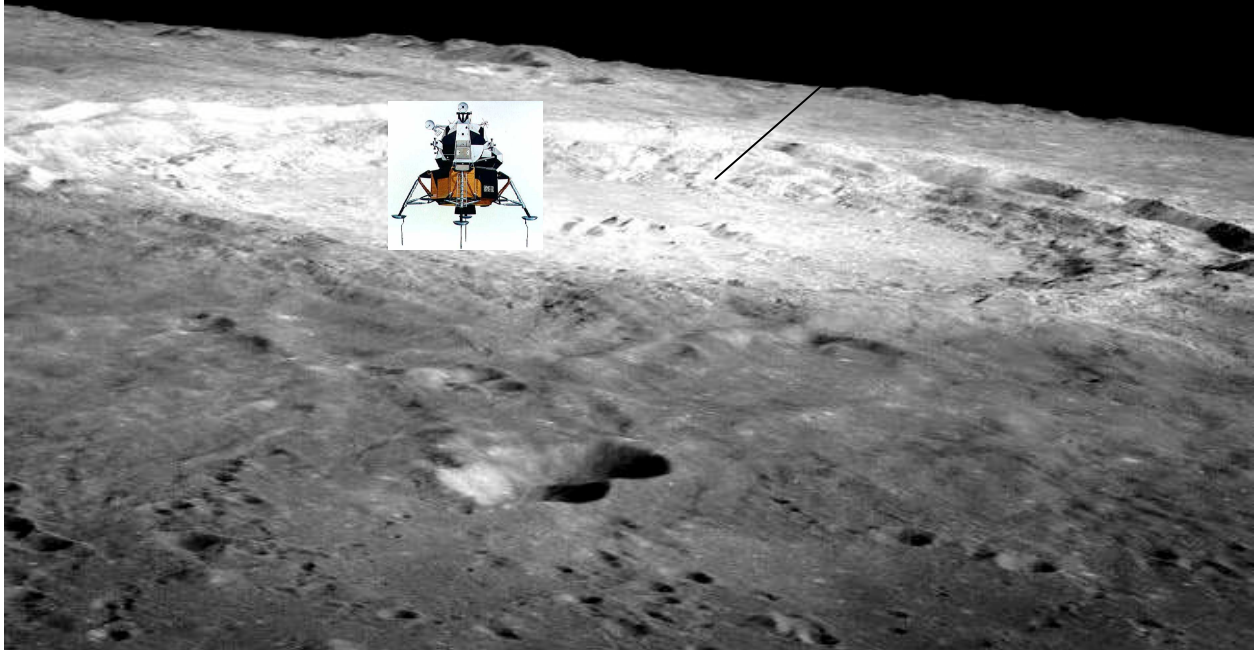

Gordon, Richard



Copernicus crater

Schmitt, Dr Harrison



The **Apollo 18** crew, **Richard Gordon**, **Dr Harrison Schmitt**, och **Vance Brand** were not allowed to visit this crater. The reasons had nothing to do with lack of money (as stated by NASA back then), in the 70's the US was the richest nation on Earth. There are many good pictures of Copenicus crater, e.g. from **Apollo 17**. Its diameter is 93 kilometres, its depth 3.8 kilometres. It is the largest crater on the Moon and is located at Oceanus Procellarum. When we see the pictures we cannot clearly see from the surface that it contains large amounts of secrets.



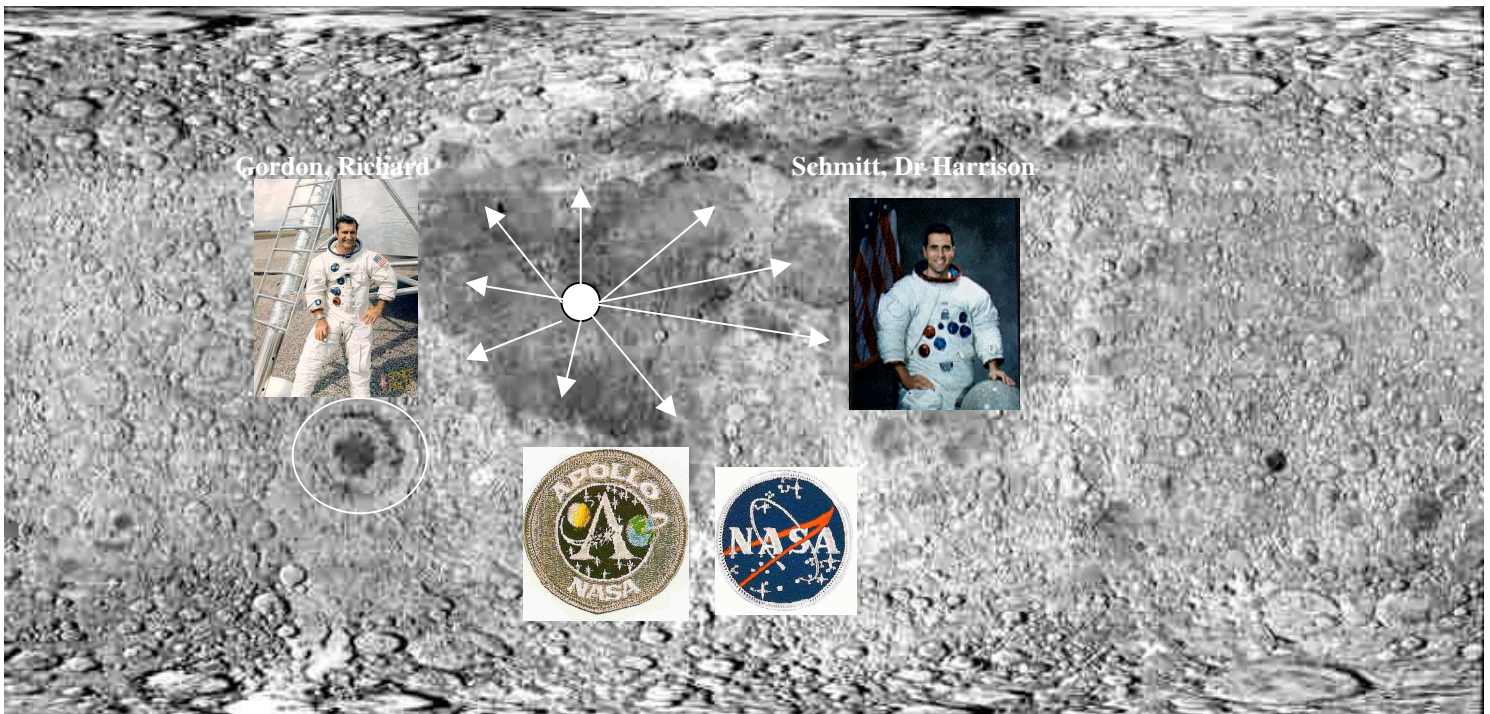

Gordon, Richard

Schmitt, Dr Harrison

If we fly above Copernicus crater it looks more secretive. Its diameter is 93 kilometres, its depth 3.8 kilometres. Below the surface, in subterranean passages, aliens carry out their top secret activities, a typical moon base below the surface, consisting of various types of controls, directed at the Earth. They are also connected to the neutron star Nemesis, which exists in our solar system since December, 2012. There must also be a landing area for space ships from, for example, the Nemesis solar system. I have marked out the most suitable landing site in Copernicus crater and I assume that NASA has done so as well. The astronauts Gordon och Schmitt were supposed to land there, stay there for a couple of weeks and examine the area using a lunar roving vehicle. Below Gordon's feet we can see one more mysterious small crater with subterranean passages. Copernicus Crater must be very secret, visitors from the Earth are not even allowed to approach it. This helps us to understand why **Apollo 18** had to remain on Earth. This secretive, mysterious Copernicus is still a very interesting subject for top-level science and to land there was initially an excellent idea. More info *Moon Mystery*, page 84.

## Apollo 18

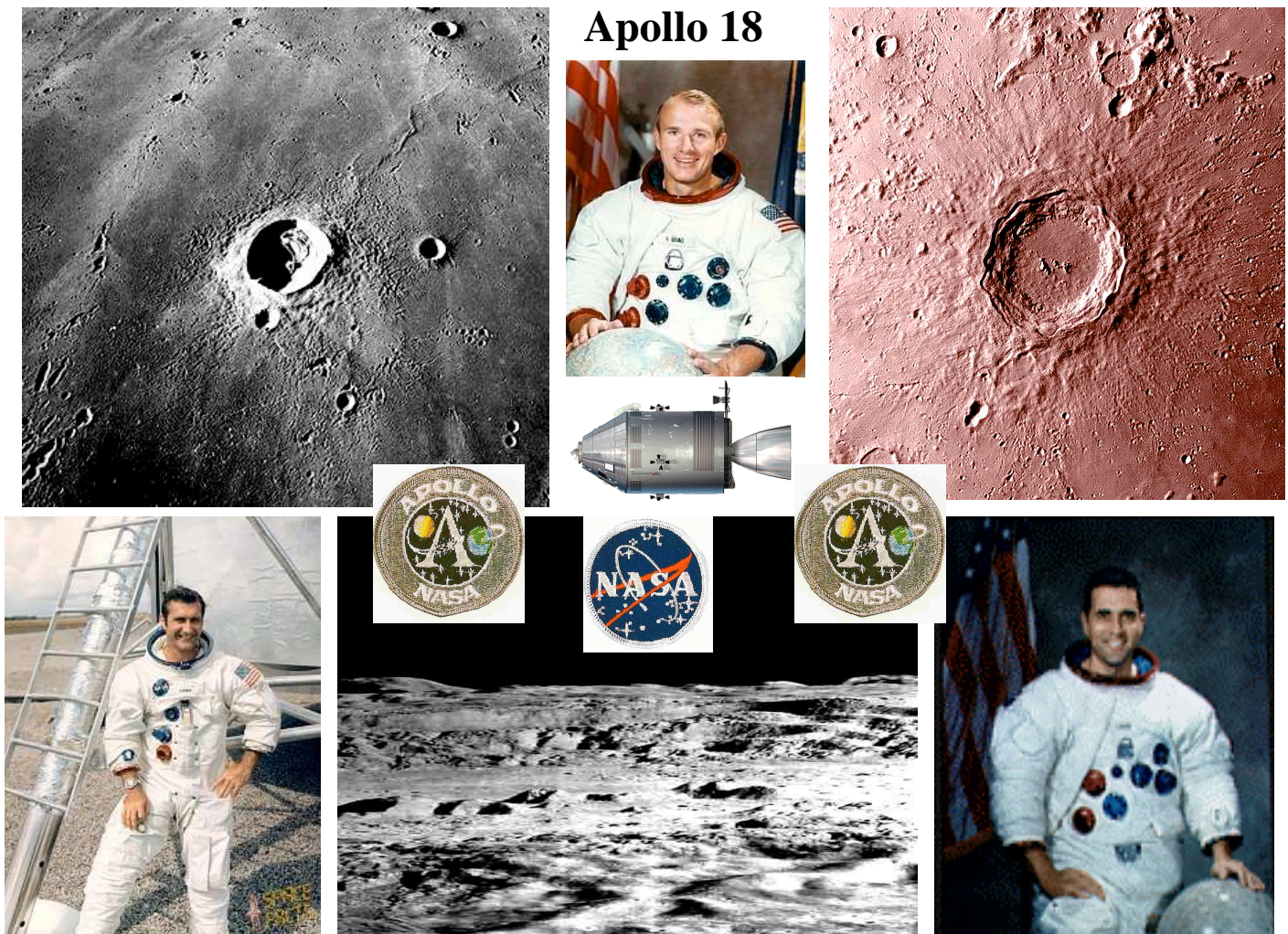



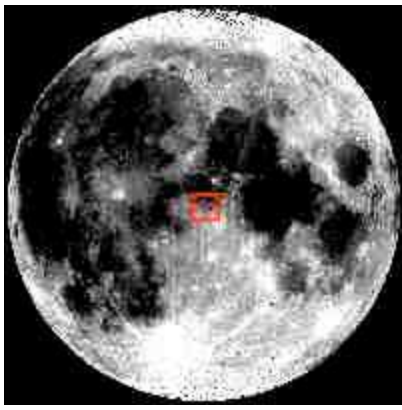

Hyginus Rille.

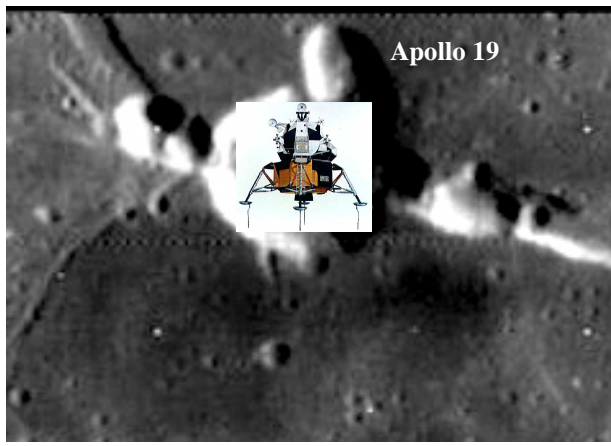

Apollo 19

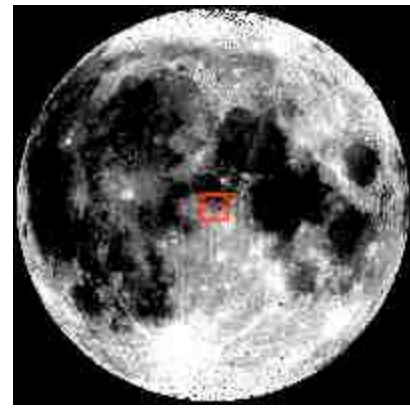

Hyginus Rille.

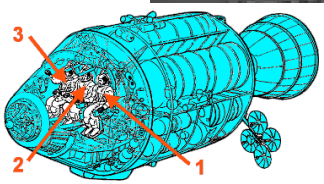

# Apollo 19, 12/12/1973

Hyginus Rille

William Pogue



NASA/GSFC/Arizona State University



Hyginus crater



Fred Haise



Gerald Carr



The **Apollo 19** crew were supposed to land at Hyginus crater in mid-December, 1973. The crater has a diameter of 11 kilometres and a depth of 0.8 kilometres. It is a small crater with a river or creek-like canal stretching from right to left. This is where astronauts Fred Haise and Gerald Carr were supposed to touch down. It seems as if there is also a moon base, on as well as below the surface.

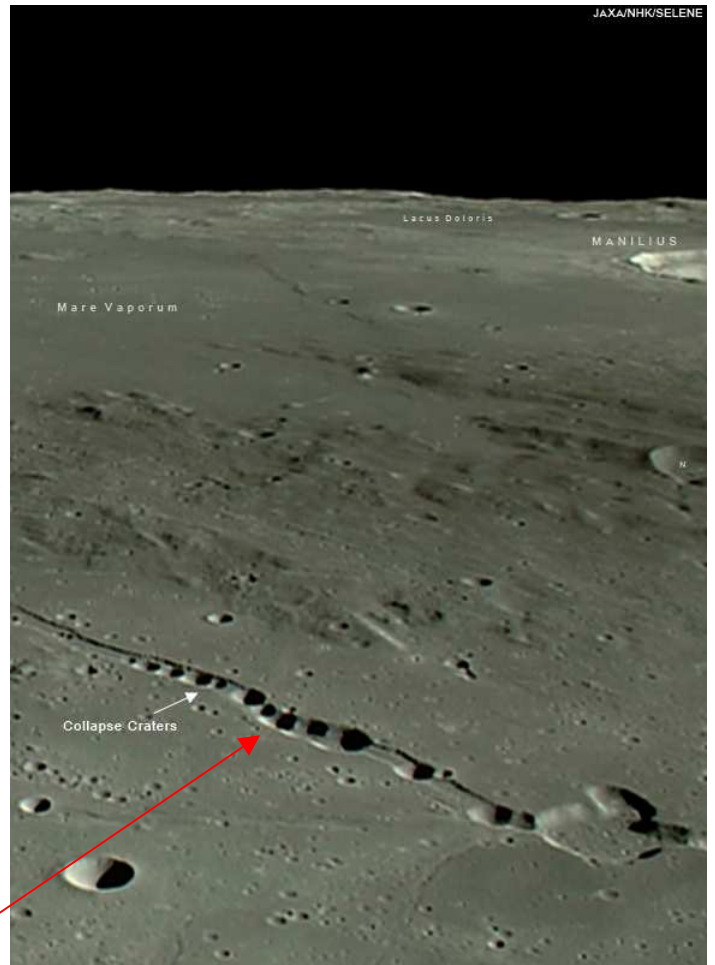
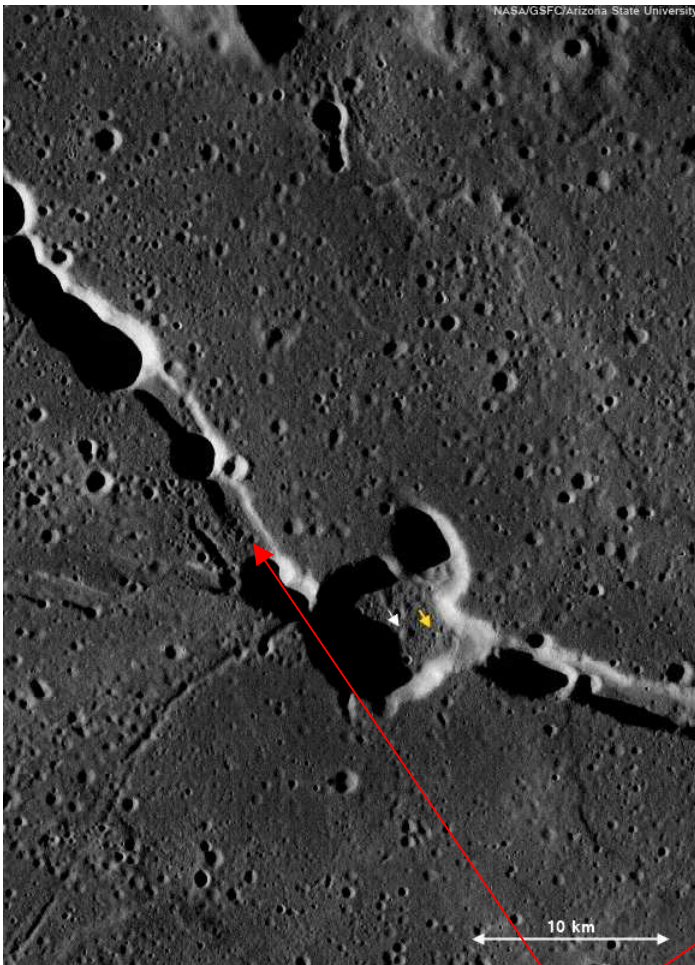
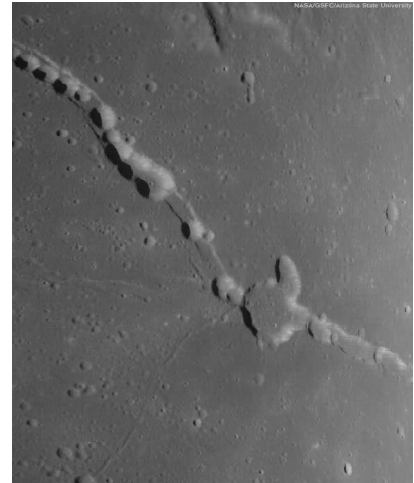
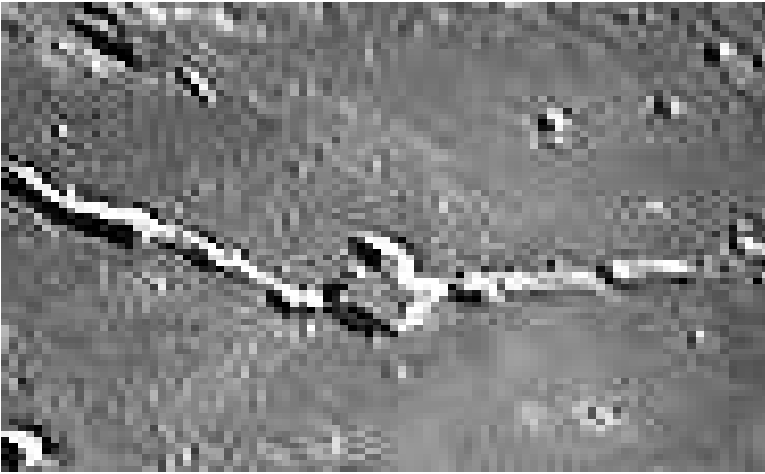

The pictures show long and wide, short and narrow canals. They seem to be constructed for special buildings and requests. We can clearly see that there is a number of small crater-like objects/buildings next to each other in a straight line, exactly following the straight structure of the canal. The pictures also show mysterious tracks.

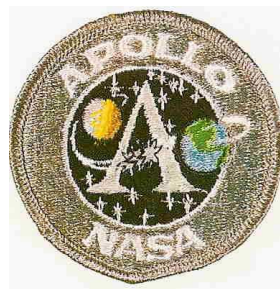

**Apollo 19**  
Hyginus Rille







Fred Haise

Gerald Carr

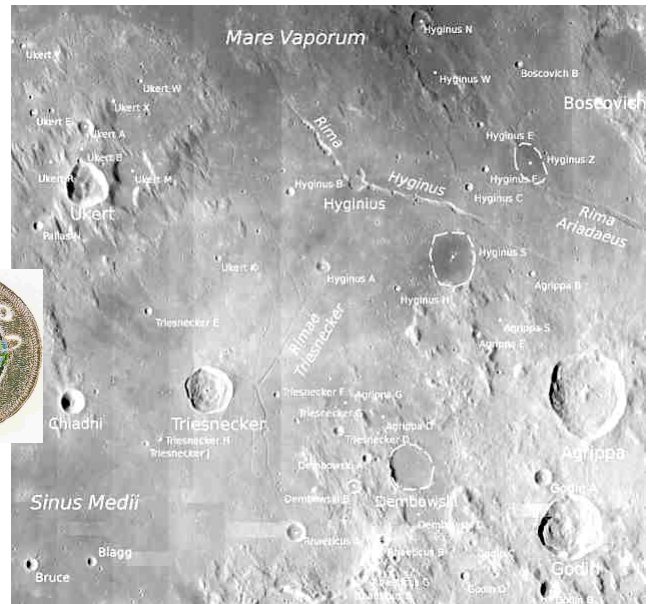
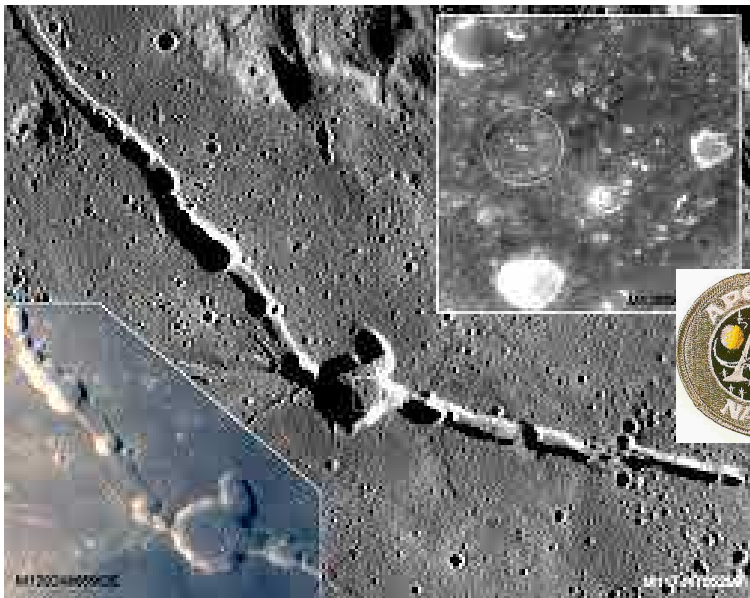
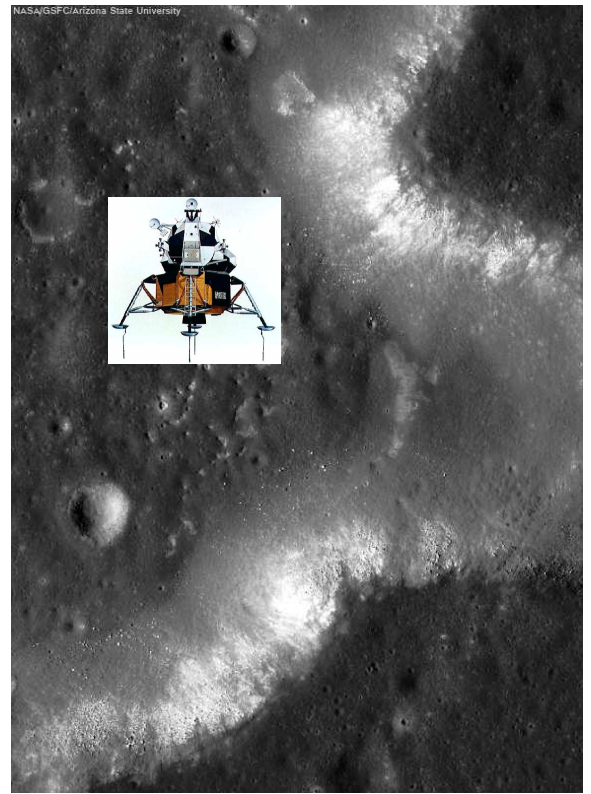

Hyginus Rille is a very interesting and mysterious area on the Moon. The pictures can confirm that some kind of a moon base exists, but we do not know to which group of aliens the base belongs. We also know that NASA was ordered to stop and Apollo 19 with crew never was launched. More info at *Moon Mystery*, page 85.

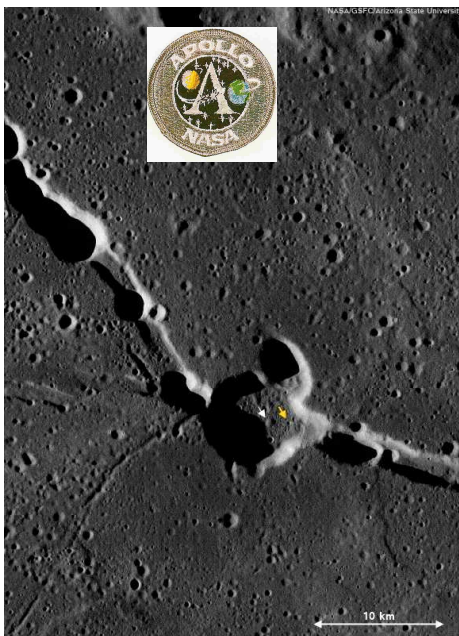

William Pogue

Apollo 19

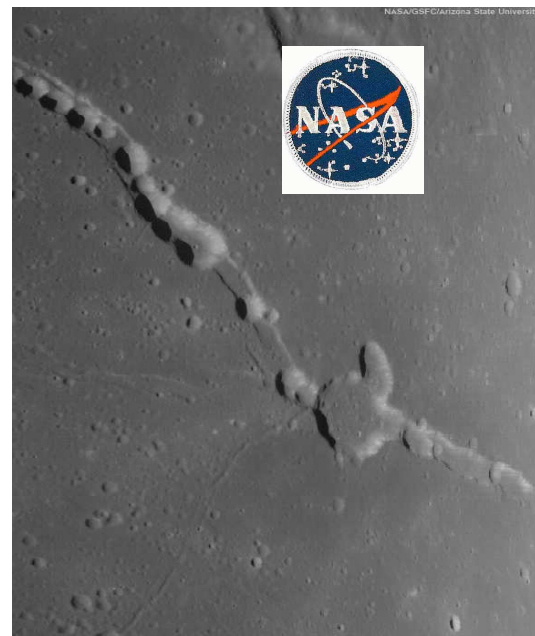



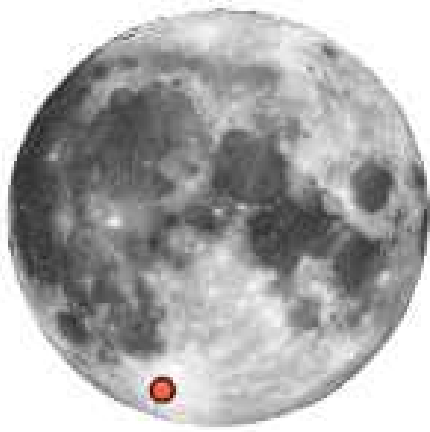

Tycho crater

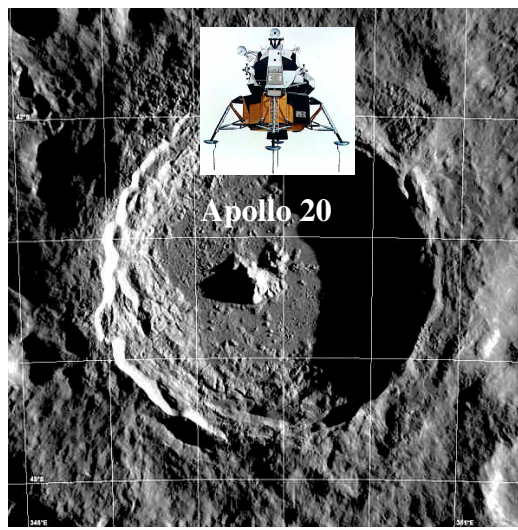

Apollo 20

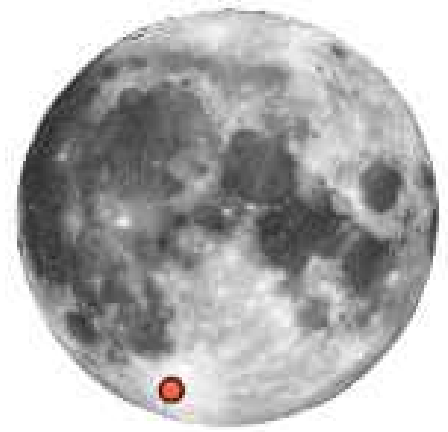

Tycho crater



Apollo 20, 07/01/1974



Jack Lousma

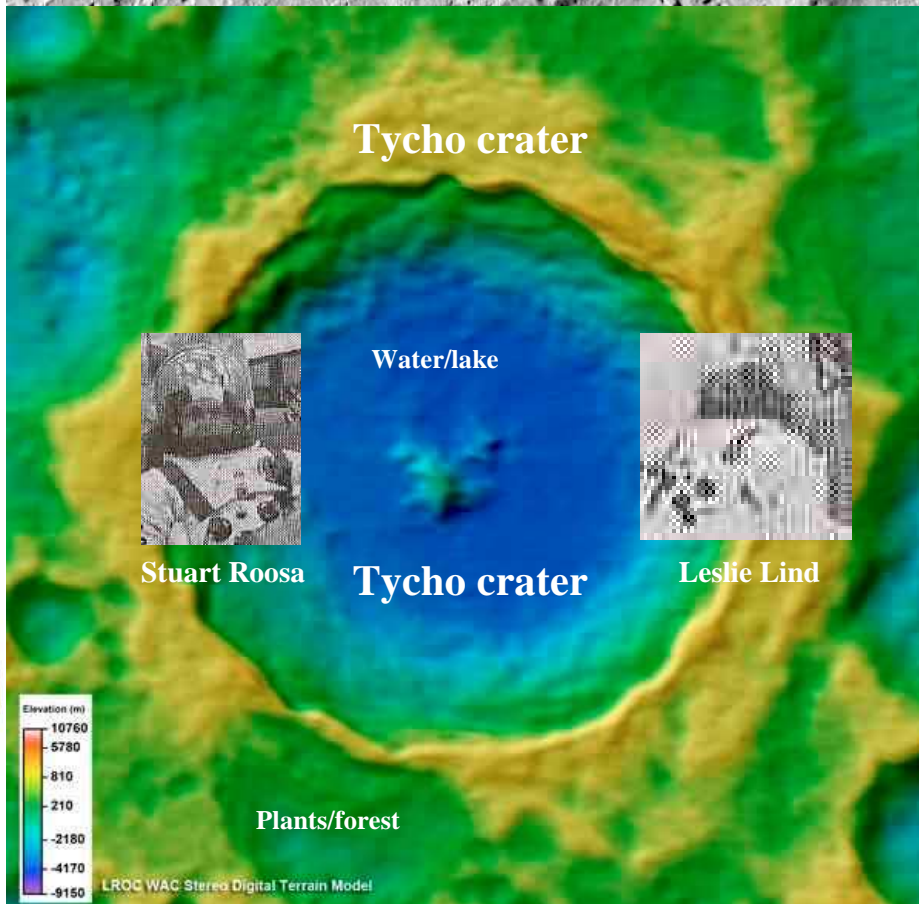
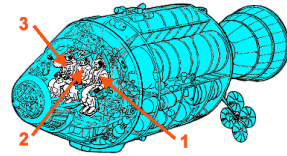
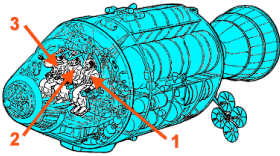

Tycho crater

Water/lake



Stuart Roosa

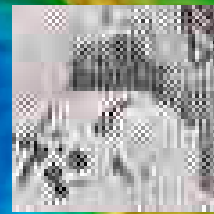

Leslie Lind

Tycho crater

Plants/forest

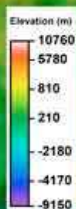

LROC WAC Stereo Digital Terrain Model

Astronauts Roosa and Lind were supposed to land at Tycho crater in January, 1974. The crater has a diameter of 86.21 kilometers and a depth of 4.8 kilometers. This also an exciting and mysterious crater, named after the Danish astronomer Tycho Brahe.



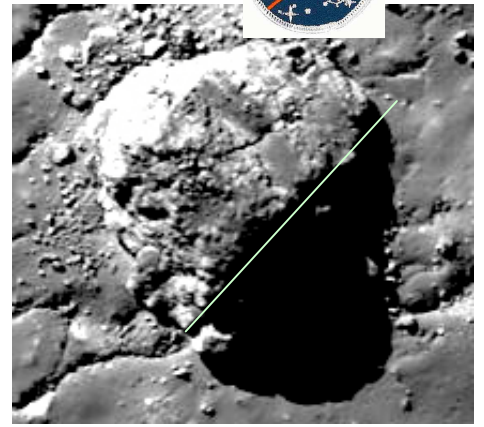
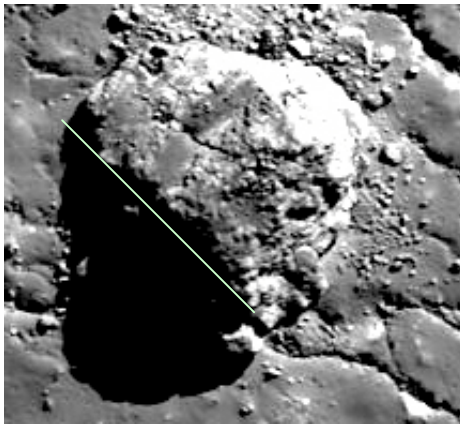
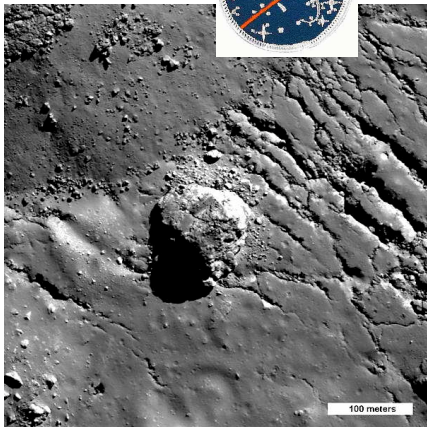
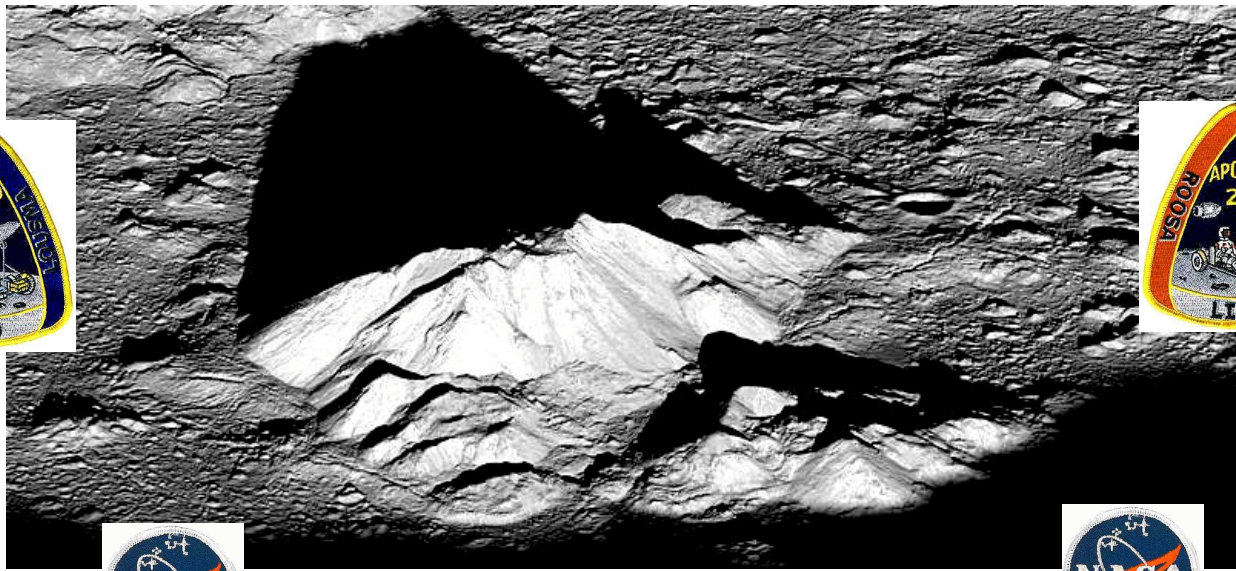

This rock looks like a skull. What is inside the rocks? – As far as I can understand, the origin of the Moon can be found in Nemesis's solar system and much of what the astronauts have seen and met originates from Nemesis, when the Moon orbited the neutron star Nemesis.

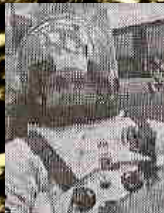
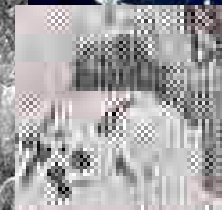
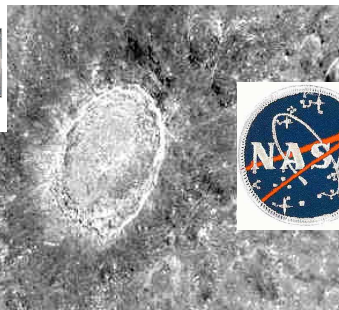
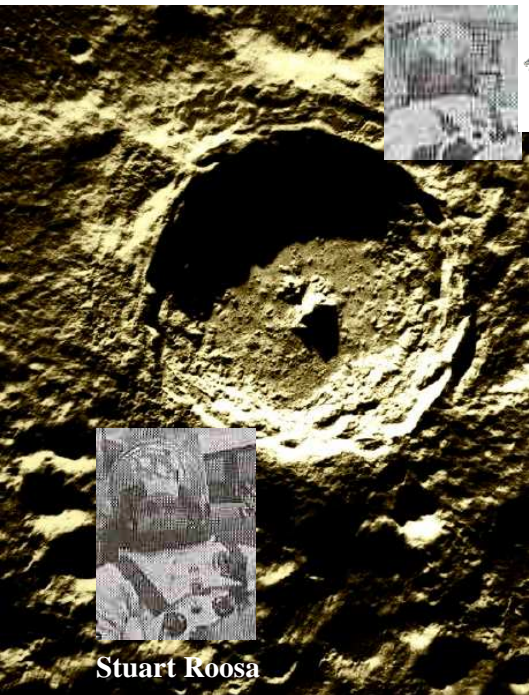

Stuart Roosa

Leslie Lind

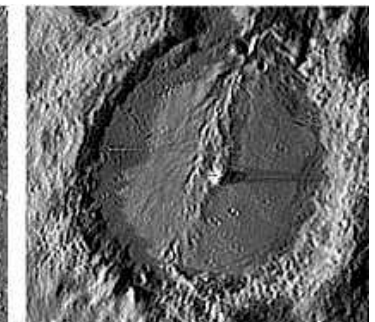
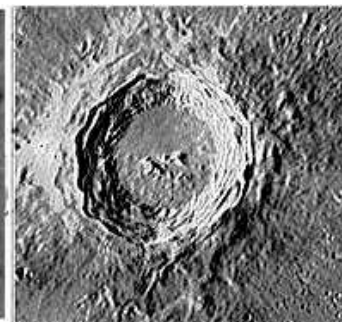
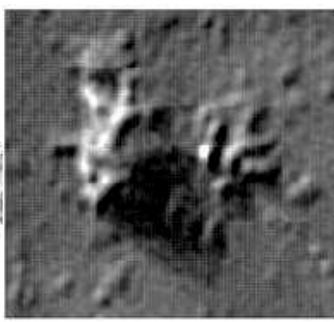
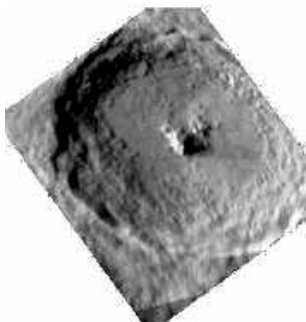



In January, 1974, Apollo 20 was supposed to carry out its last flight to the Moon to land at Tycho crater, according to NASA. The astronauts were Roosa and Lind. Tycho crater is still a very interesting and mysterious area on the front face of the Moon. We can ask ourselves if there is also a Moon base belonging to some group of aliens on the front face of the Moon. If you do not have a permit, you cannot land there, that's it. Remember: The Moon is not managed from the Earth and powerful men and women on Earth have nothing to do with the Moon. NASA's **Apollo 17** carried out its last flight and landing in 1972 and Apollo 20 was to be the very last according to NASA in 1974. More info at *Moon Mystery* page 86.



# Area 51

# Area 51

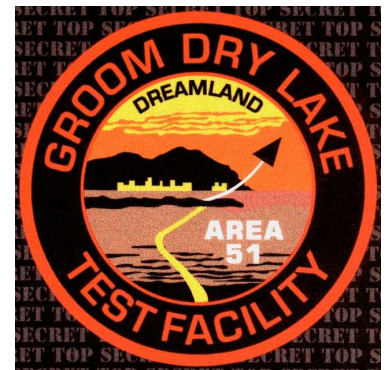
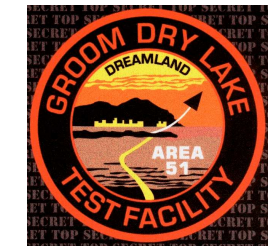

Let us start with Area 51. **Area 51** is the non-official name of an American Air Force base. It is located in Lincoln County, Nevada, on the dried-out bottom of *Groom Dry Lake* in the Nevada desert, around 160 kilometers north of Las Vegas. The area is also known as Edward Air Force Base, where several times the American space shuttles Enterprise (test flight), Columbia, Challenger, Atlantis, Discovery Endeavour landed.

In 1968 the Soviet Union released a number of pictures of a secret American test base 120 kilometers from Las Vegas, in the middle of nowhere. Nobody reacted until the Soviet Union, in 1983, released new pictures of the base, now considerably expanded. Shortly after the second batch of Soviet pictures, persons started to come forward and state that the American government tested new super arms at the base, "mind control weapons", using a so-called black budget. This base is AREA 51, by the authorities named **Project 51 USAF**.

The facilities have many names, e.g. **Nellis Test Range** (official name for the area of which Area 51 is one part), **Dreamland** (often used by pilots as a name of the prohibited air area), **Groom Dry Lake** (the name on the maps).





An important disclosure towards the end of the 1990's was that the Americans co-operate with aliens, so-called "extra terrestrials" or "ETs". I write more about these aliens and their origins in my book *Global Change and the End of Time*, 2007.

One man behind the disclosure was Robert "Bob" Lázár. He is a self-appointed scientist who maintains that he has worked at what he calls S-4, a section of the top secret military base AREA 51 in the Nevada desert outside Las Vegas. S-4 is situated 16 kilometres south of Groom Lake/Area 51. He states that he was employed in December, 1988 and left the job in April, 1989. He says that a nuclear accident took place within the installation which made it possible for him to get a job since three scientists had died in the accident. His assignment was to "back engineer", i.e. to dismantle an object and then try to rebuild an exact replica. He calls the vehicle he worked with the "sport model" and he has described it as in the pictures below. After having violated his professional secrecy, stolen a quantity of the radioactive substance 115 and on three occasions invited his friends to observe test flights with these vehicles, he meets the press to speak his mind about what is going on in S-4, Area 51. This is Lázár's personal version but there is evidence substantiating his story. I will save that for my conclusions.

Now, Robert Lázár is not the only one who has made the story public, but he is the only one to have used his proper name. Others are *Jarod 2*, a technician who claims that he has helped designing flight simulators for production of alien vehicles (called *JAY-rod*). Jarod 2 is a 70-year-old man who nowadays lives in Pennsylvania, USA, and claims that he worked at Area 51 for 30 years (from the mid-50's to the end of the 80's). His job was to design a flight simulator to be used when learning how to operate the alien saucers. He built this vehicle in co-operation with a real alien – *Jarod 1* – see below. The name is a reconstruction of the proper names of the aliens. *Jarod 2* says that he knows that three of these flight simulators are still used today. His description of the interior of these simulators coincide with Robert Lázár's description and he also tells the story about how the armed forces also developed their own earth-bound UFOs using two crashed alien UFOs at the end of the 1940's and the beginning of the 50's. We do not yet know how it was possible to get help from a true alien, not yet...



Alfred is another man. He worked at Nevada Test Site at the beginning of the 1960's and he claims he has seen alien vehicles. He goes on to tell us that Richard Nixon was appointed head of a "Supreme Government" in 1953, much like MU-12, which was supposed to handle all incoming UFO issues. He also claims that *Jarod 1* consumed a lot of boron (a chemical substance) to prolong his life. He also states that his superiors have said that aliens speak a more refined version of Hungarian. "Because it is the most difficult language to learn." I have evidence for this, too.



Robert Lázár



Jarod 1, an alien, hybrid

(JAY-rod).

Jarod 1, an alien, hybrid



Jarod 1 in his American car, on his way to work.

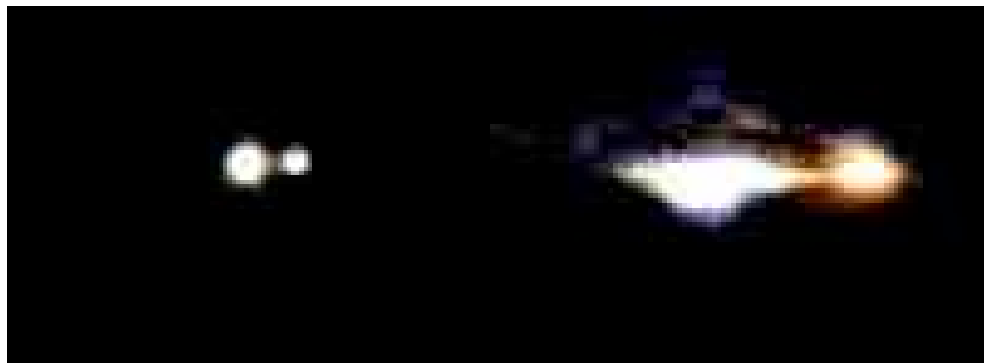
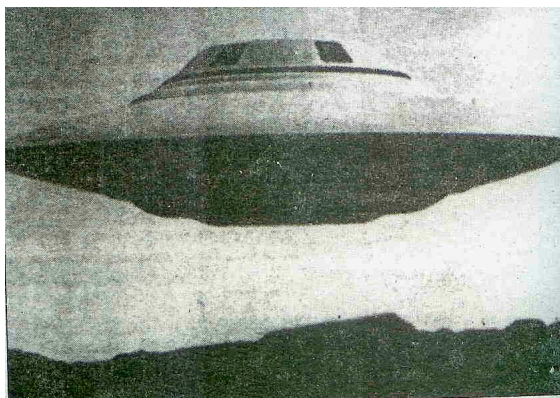

UFO/Saucer above Area 51





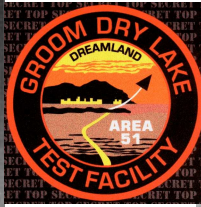
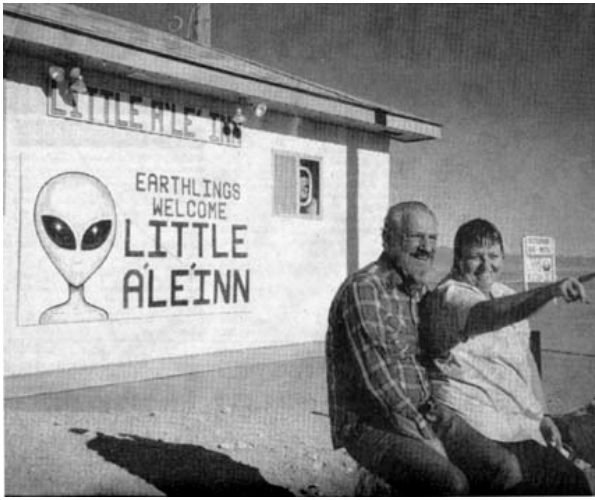

A UFO culture has developed in Nevada, connected to Area-51



Alie



Extraterrestrial highway Route 375 is still a military area

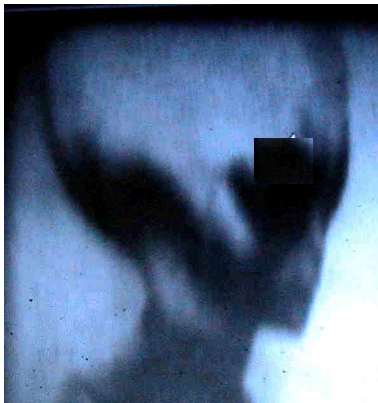

Franklin Delano Roosevelt, (1882 - 1945), President 1933-1945 USA

Jarod 1, one of the aliens, head of Earth activities, Area 51, S-4. Roosevelt is said to have filmed him during the meeting.





Jarod 1, alien  
Head of the aliens,  
The Earth, Area 51,  
S-4

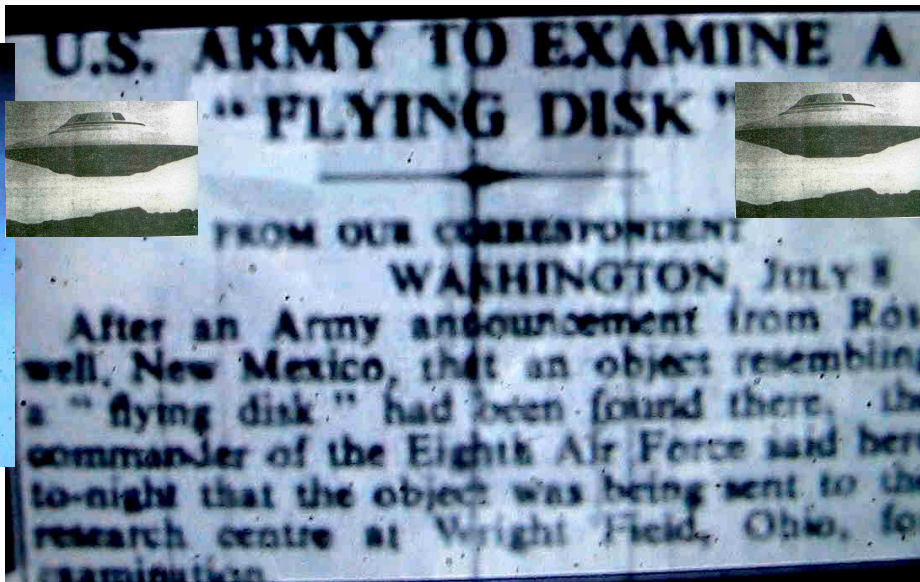

Franklin Delano  
Roosevelt, (1882 - 1945),  
President 1933-1945  
USA

*Franklin Roosevelt*

This document is from Roosevelt's time, when he travelled to New Mexico to meet the aliens' boss in a small surveillance ship (later on called "JAY-rod"). The boss was probably Jarod 1. A co-operation deal was struck between the aliens and the US, codenamed *Black aircraft*. The deal included research concerning technology as well as top secret biological activities. That is how Jarod 1 and his aliens came to Area 51, S-4. Roosevelt is said to have filmed him at the meeting.



Jarod-1, alien  
Leader of the aliens,  
Earth, Area 51,  
S-4



John Fitzgerald Kennedy,  
(1917-1963)  
President 1961-1963  
USA

*John F. Kennedy*

The USA were permitted to travel to and land on the front face of the Moon. It was President Kennedy who received this message from Jarod 1. Thereafter we could read this in the world press: "The American President John F. Kennedy announced on May 25, 1961, that the US will put a human being onto the Moon before 1970. I Believe We Should Go to the Moon".

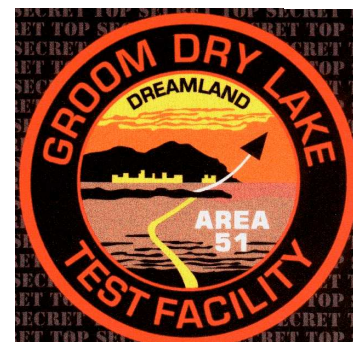

The aliens are well-known in the USA, especially in the areas surrounding Las Vegas and Nevada. There is much more information about them on the Internet. All Americans acknowledge the fact that the aliens must be permitted to live and work in the US. Only the president can grant this permission.

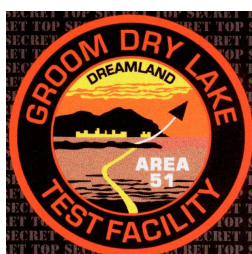

From Area 51 to Vandenberg Air Force Base,  
Space Launch, California





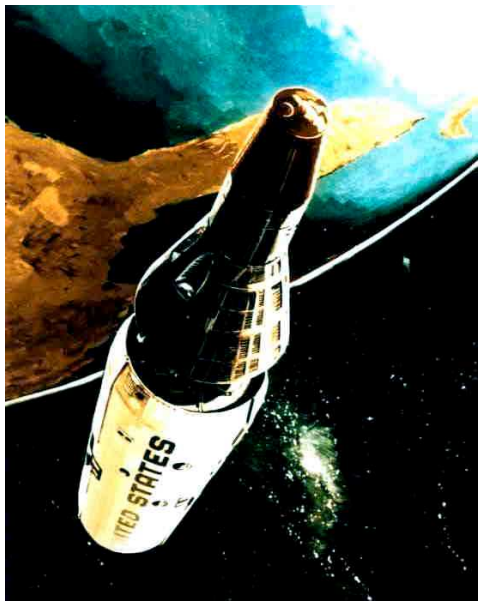

**Manned Orbiting Laboratory (MOL)**

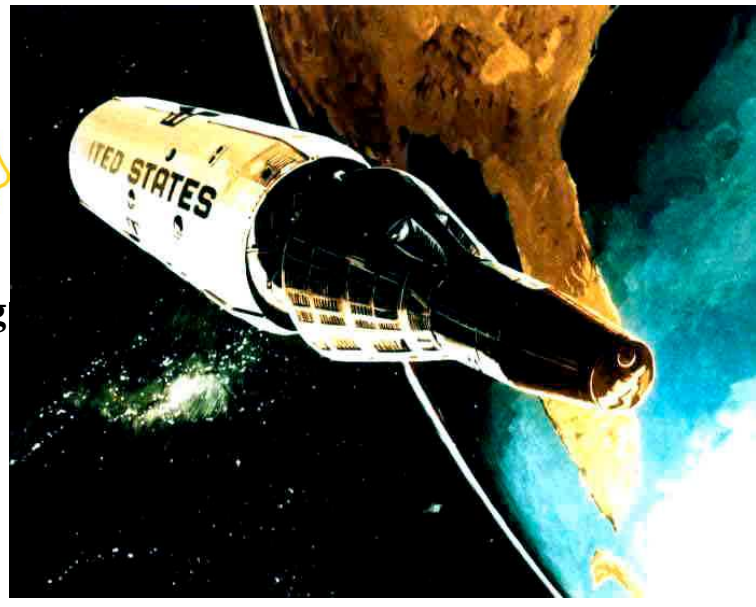

Vandenberg Air Force Base, Space Launch, California



Vandenberg Air Force Base, Space Launch, California,  
Corresponds to civilian NASA Kennedy Space Center, Florida

The NASA civilian activities parallel military activities based on manned space flights around the Earth in a so-called MOL, Manned Orbital Laboratory.

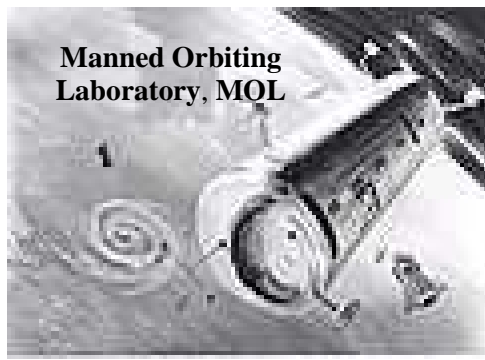





U.S. Air Force introduces 14 of 17 MOL astronauts in 1965. Top line: Herres, Hartsfield, Overmyer, Fullerton, Crippen, Peterson, Bobko, Abrahamson. Bottom line: Finley, Lawyer, Taylor, Crews, Neubeck, Truly (USAF) Seven of these later appeared in NASA's STS mission 1981-2011. The full MOL-programme was revoked on June 10, 1969.

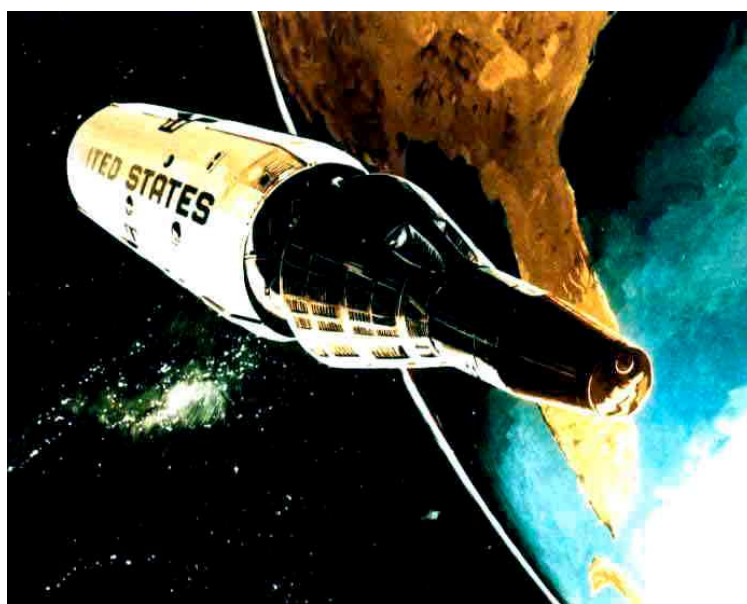

### MOL 3

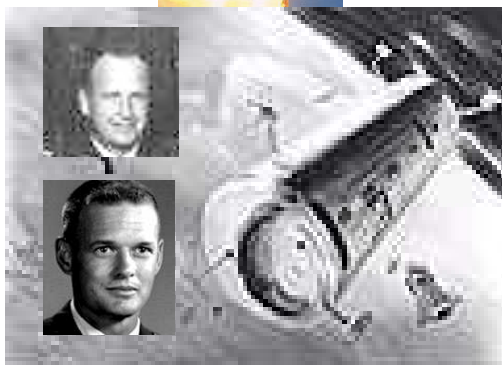

30-day visit to MOL

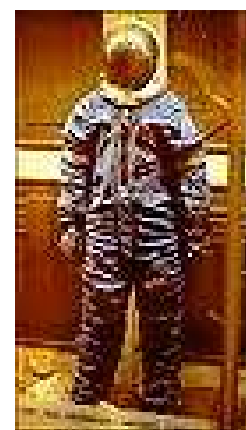
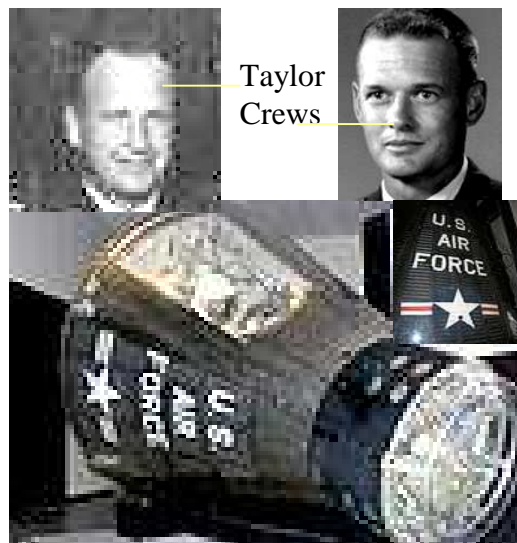

MOL 3 was to be launched on February 1, 1972, from SLC-6 in Vandenberg ABF, California, carrying USAF astronauts James A. Taylor and Albert H Crews. Taylor and Crews would have spent 30 days in the laboratory in connection with a DOD (Department of Defense) mission.





# MOL-4

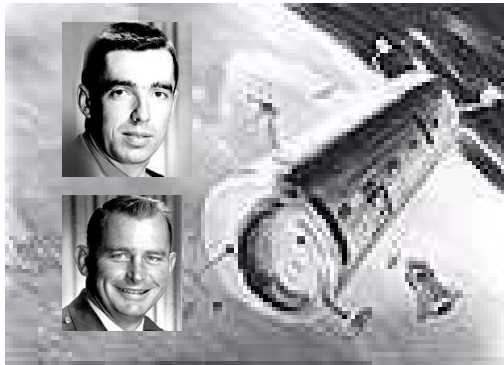

40-day visit at MOL

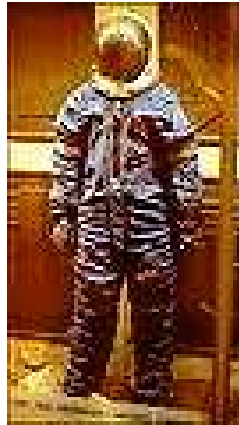
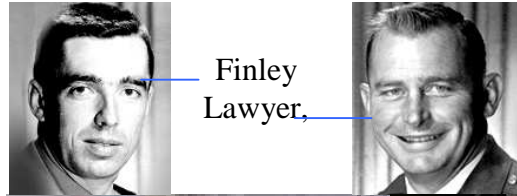

November 1, 1972, was the planned date for the launch of **MOL 4** from SLC-6 in Vandenberg AFB, California, with USAF astronauts John L. Finley and Richard E. Lawyer. Finley and Lawyer would spend 40 days in the laboratory on a DOD mission.



# MOL 5



vistelse på MOL i 40 dagar

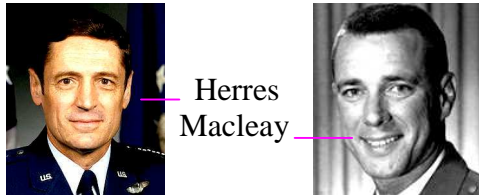

**MOL 5** was to be launched on August 1, 1973, from SLC-6 in Vandenberg AFB, California, with USAF astronauts Robert T. Herres and Lachlan Macleay on board. The planned visit for Herres and Macleay comprised 40 days in the laboratory, a DOD mission.



# MOL 6

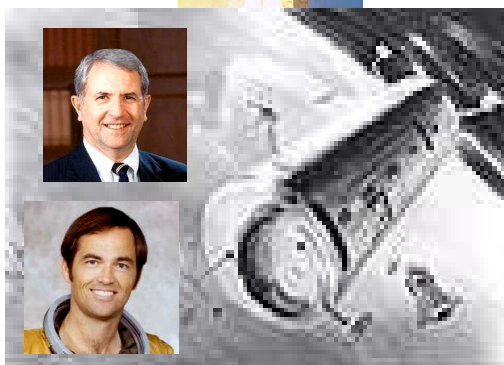



40-day visit at MOL

May 1, 1974, was the set date for the launch of **MOL 6** from SLC-6 in Vandenberg AFB, California with USAF astronauts Robert Richard H Truly and Robert Crippen. Planned visit: 40 days in the laboratory, a DOD mission.



MOL visit: 40 days

**MOL 7**



February 1, 1975, was the set date for the launch of **MOL 7** from SLC-6 in Vandenberg AFB, California with USAF astronauts James A Abrahamson and Francis G. Neubeck, awaiting a period of 40 days on a DOD mission in the laboratory.

The MOL-project was planned all the way to MOL 14, but because of financial issues the whole programme was cancelled on June 19, 1969. Between 1965 and 1969 the project cost between \$ 1.5 and 3 billion, after that the Vietnam War claimed what money was left. About 40 years ago \$ 3 billion was a gigantic sum, especially since no spaceflight took place. Some of the USAF astronauts later on joined NASA and took part in the STS project.

**Apollo-18 USAF/DOD**



**Benjamin Anderson 3, Nathan Walker 1, John Grey 2  
Apollo-18, USAF/DOD, 1974, December**

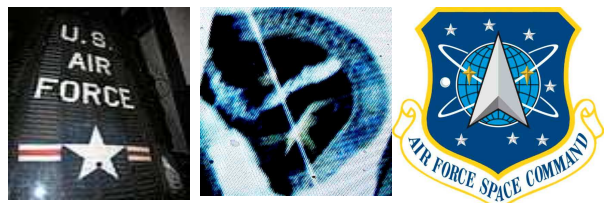

**Apollo-18 crew**

Apollo-18 was a DOD mission which was launched from Vandenberg Air Force Base in California in December, 1974. The mission had nothing to do with NASA.



As far as I understand, the top secret mission was, together with the Soviet Union, to carefully map the area where Apollo 18 was supposed to land, a DOD mission. NASA revoked its mission in connection with Apollo 18, 19 and 20, probably because they were not allowed to land in the predetermined areas. Another reason was that NASA refused to participate in military activities on the Moon. The funding was withheld and transferred to the Vanderberg DOD project to be used for Apollo 18, 19 and 20 in a renewed military project. In that way NASA lost the funding for the three final civilian space flights. Astronauts Benjamin Anderson, Nathan Walker and John Grey were in the group of USAF astronauts who had volunteered to carry out the mission.

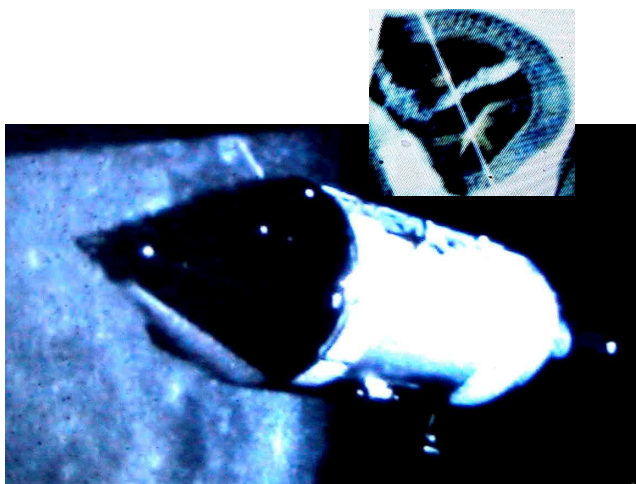

Grey stayed in the mother ship Freedom and orbited the Moon while Walker and Anderson touched down.

Walker and Anderson, in a disconnected Liberty, ready to land on the front face of the Moon.

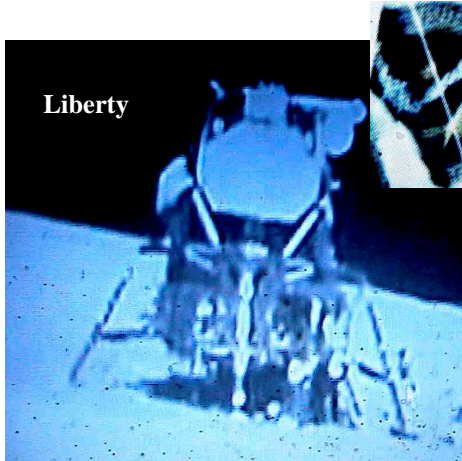

Liberty landed on the front face of the Moon according to plan, the astronauts were constantly in touch with ground control. But the records do not reveal exactly where Liberty landed. But it was probably near the Soviet lunar probe, one of the earlier landing sites for the Soviet probes. More info at *Moon Mystery*, page 87.



The first astronaut to disembark from the lunar module was Commander Walker, followed by Anderson. They placed the American flag outside the module.







After that a number of surveillance and control instruments and secret equipment were set out outside Liberty. The DOD mission was directly aimed at the aliens. The equipment worked well.

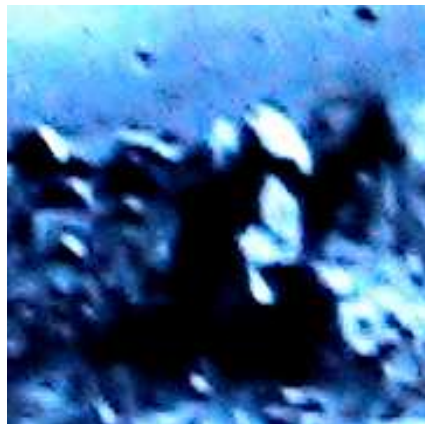

When the crew had set out the various instruments they went back to Liberty. They thought they heard strange noises and one of the cameras adapted to the module recorded that a creature formed as a rock had started to move. The ground control claimed that detectors caused the noise while Anderson was contemplating a small, mysterious piece of rock on the ground near him. These were activities during the first day on the moon and crew suspected they were not alone.



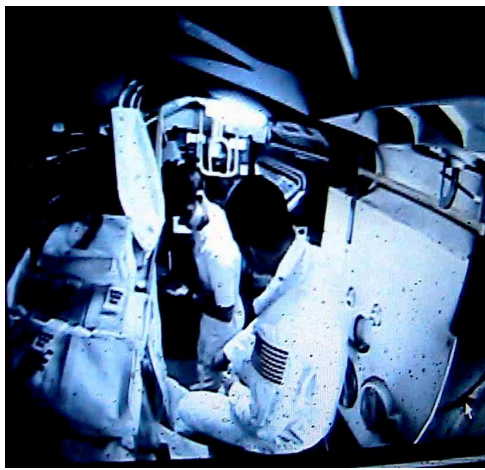

During the whole evening, in the lunar module Liberty, their temporary lodgings, Walker and Anderson discussed the strange and mysterious events from the first day. They never received any real answers to their questions from ground control. They were ordered to go on exploring the area surrounding Liberty.

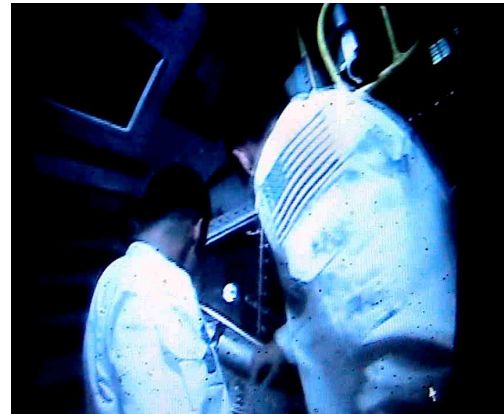
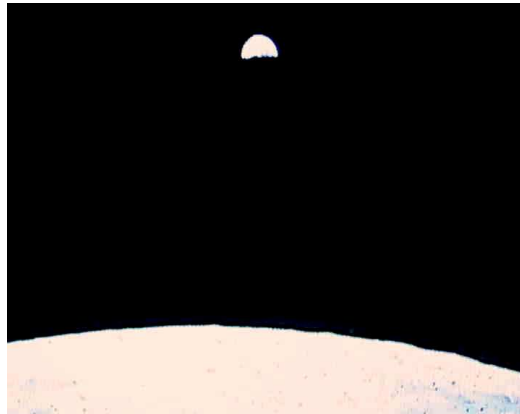
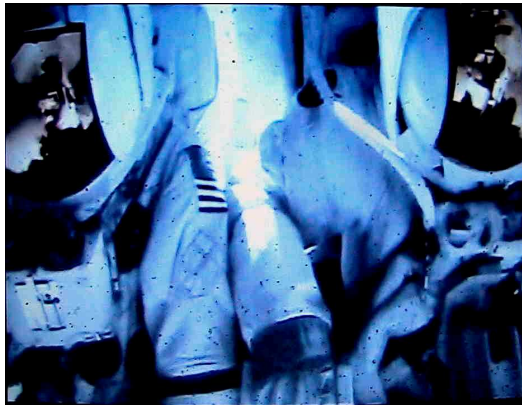

This is what the Earth looks like in the morning, from Liberty's windows. The question is what the crew were thinking when they looked at the Earth from the surface of the Moon, totally among superior aliens.





The day started, according to reports, with extensive exploration some distance from Liberty. The crew used the lunar roving vehicle.

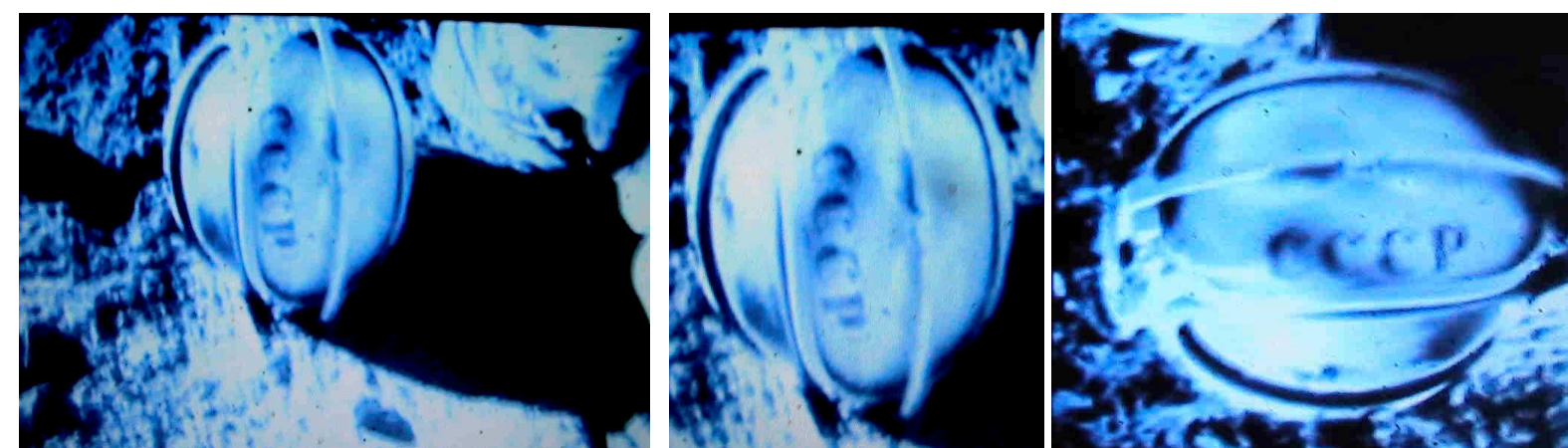
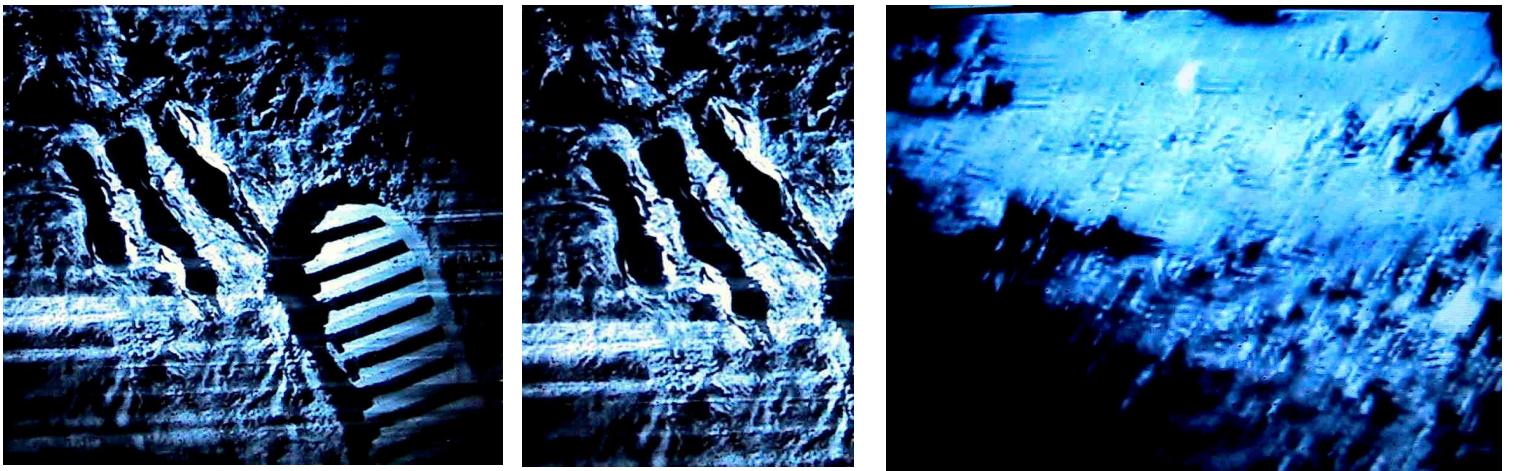
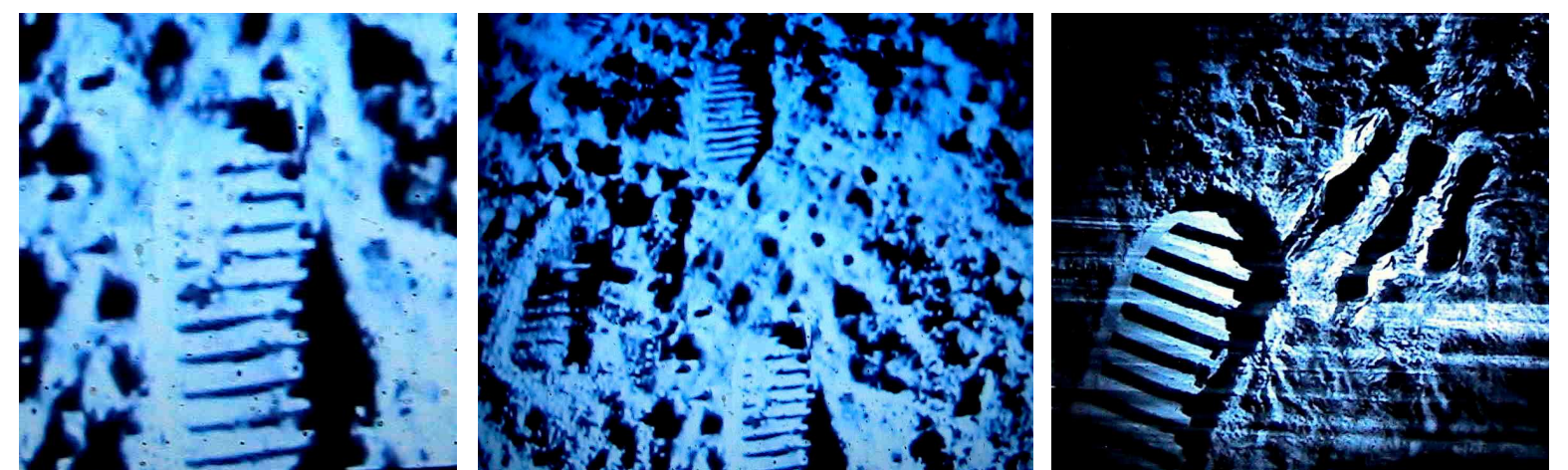
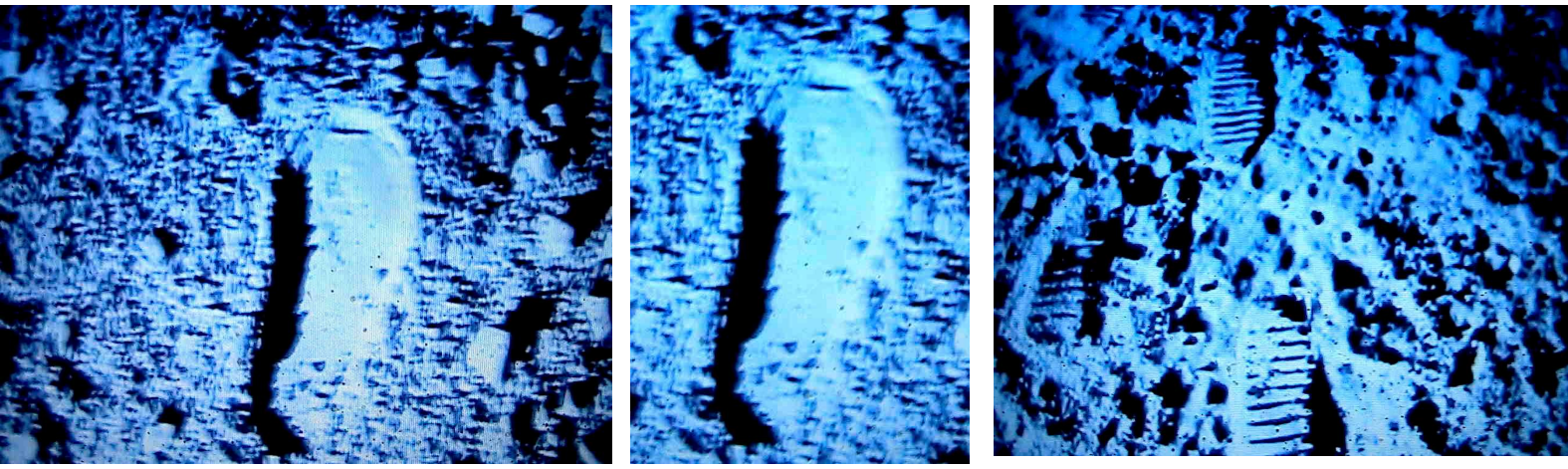

They discovered mysterious footprints from an animal and a human being. The prints took them to a crater where they found a dead Soviet cosmonaut. The helmet is clearly visible. They continued along the tracks...



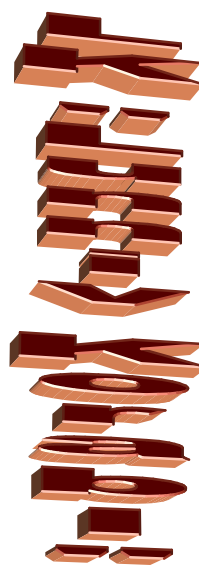
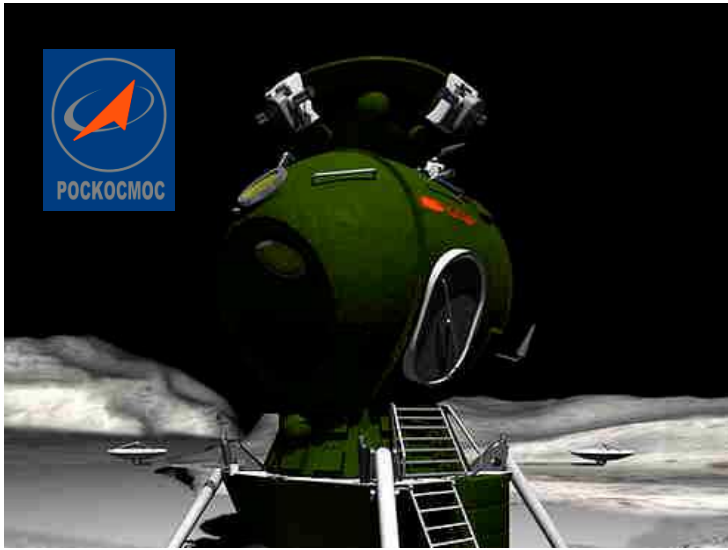
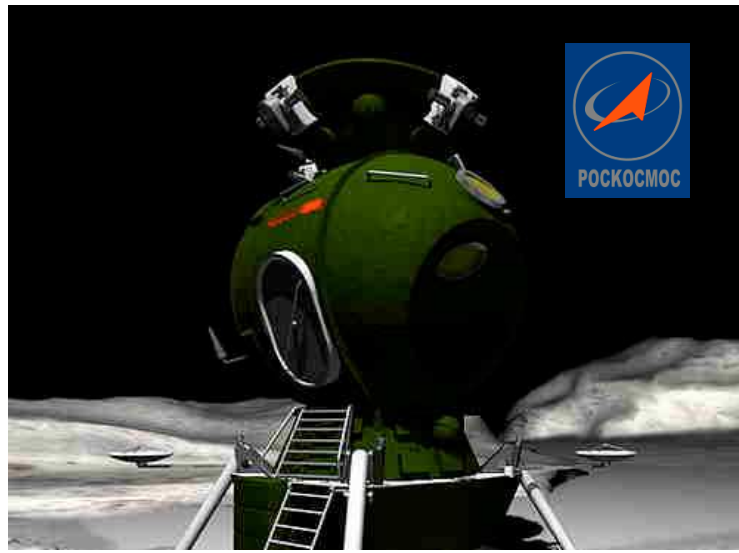

They halted at a lunar module, (**Lunniy Korabl, LK**). It was empty inside, no cosmonaut, but everything was soiled by blood. In spite of all this blood, all instruments functioned properly. Outside the module was a dead cosmonaut. The first question they asked themselves was what had happened and why. The module was constructed for one single cosmonaut. The direction of the American crew was decided by the ground control on Earth and this direction led them to the Soviet lunar module. This was called “an exploration.” Since Walker and Anderson did not see the Soviet lunar module from Liberty’s landing site, there may have been varied-sized hills at a distance of 1-3 kilometres in the surrounding area. – We can all understand the shock and nightmare that met the astronauts’ eyes.





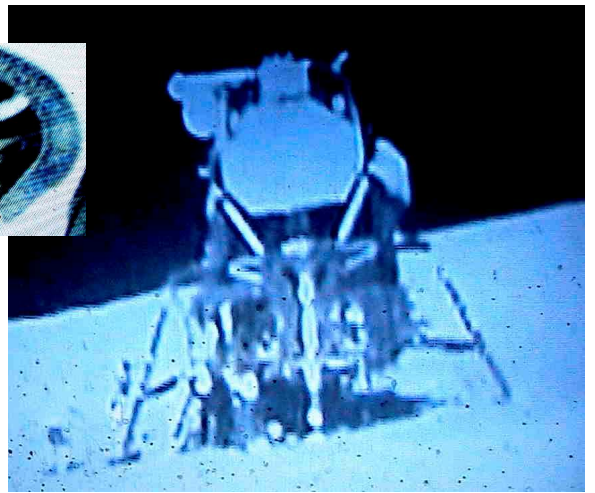

After the horrible experience between the two modules, the crew returned to Liberty. They talked about the day's bloody discovery and continued their communication with Vandenberg ground control.

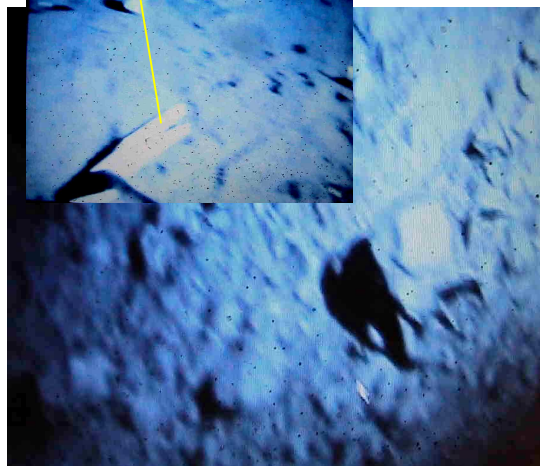
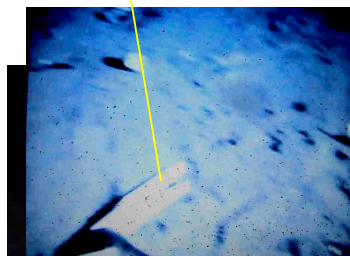
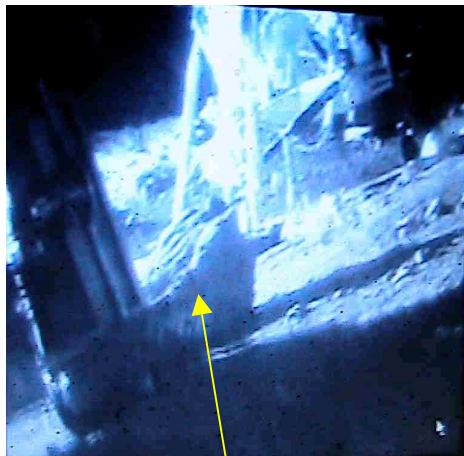
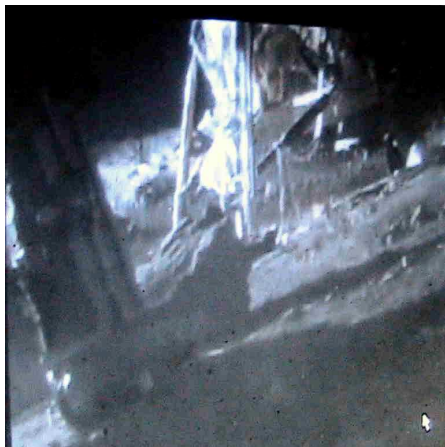

Next day the crew noticed that the American flag was moved and lay by the foot of the lunar module. Walker found a footprint of an animal (an animal-like, moving moonstone) which he regarded as proof of alien life. Besides, Liberty had been damaged by a terrible shake which rendered is unusable.



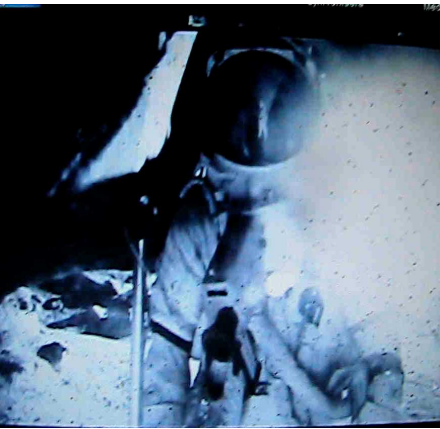
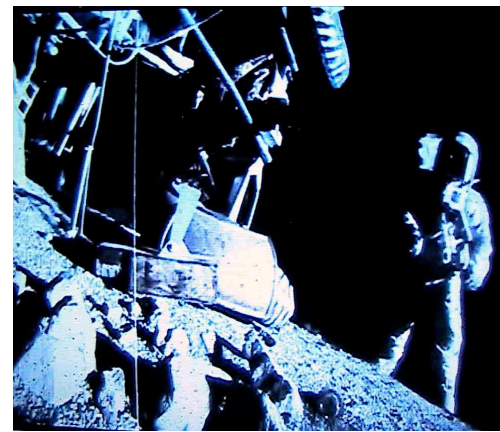
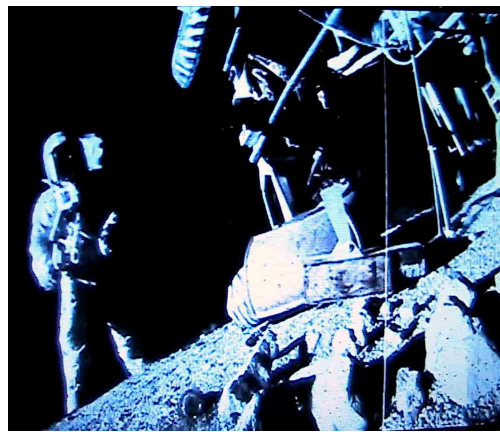

The crew walked around Liberty and noticed that the module was in a really bad state. All the instruments they had placed outside Liberty the day before were out of order. Contacts were also severed with ground control, the mother ship Freedom and the astronaut John Grey.



Walker thought that something had got inside his space suit (it was a spider), he felt sick and fell down. Anderson helped him. For a moment Walker lost consciousness and when Anderson asked him how he was, Walker had forgotten the fall, he remembered nothing.

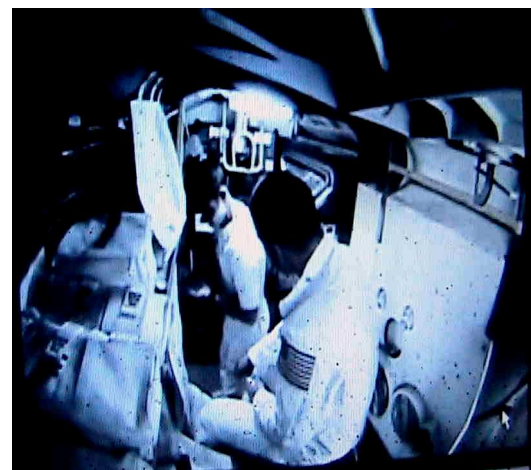
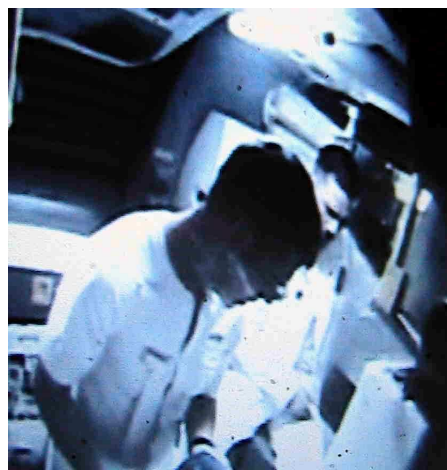

In a nightmare the crew tried to find out how to leave the Moon. Communication was impossible and Liberty was out of order.



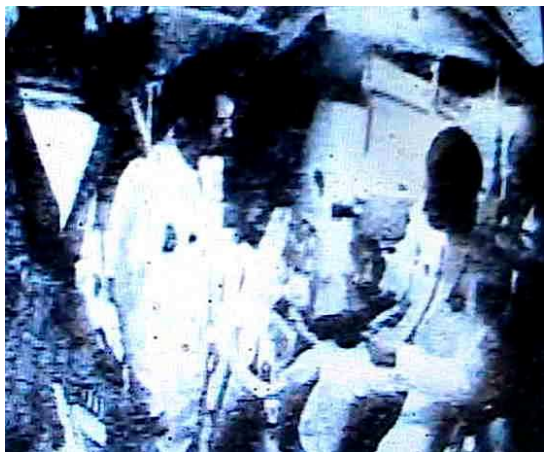
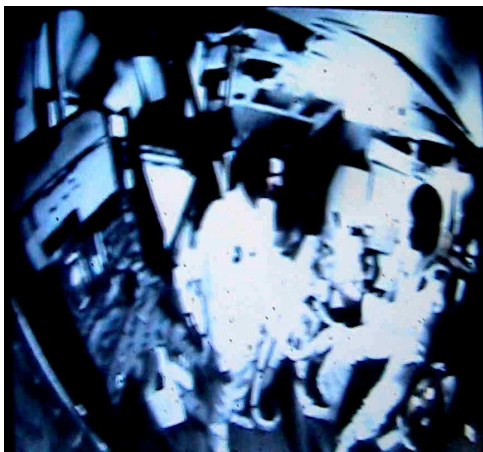

Walker felt a bit strange and checked his suit.

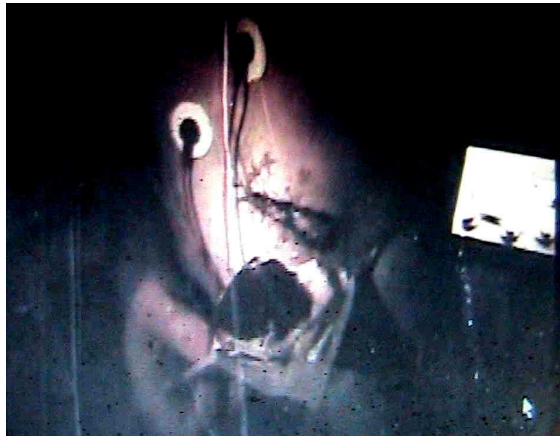
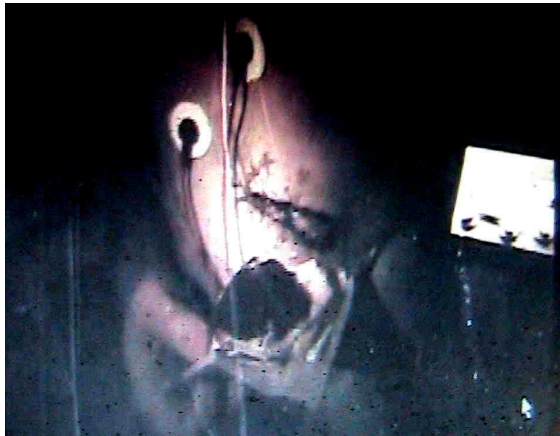

He found a big wound on his chest.



Anderson took out a moonstone from his pocket ...



The wound is shaped like a spider, which Walker found unpleasant



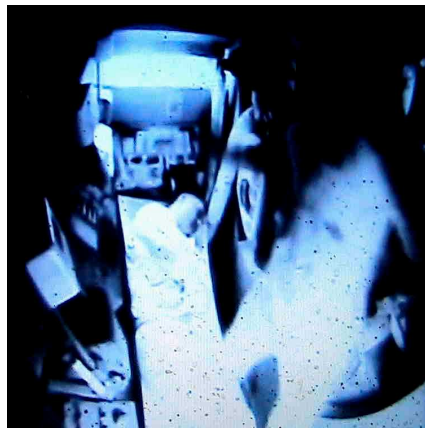

Walker noticed that a camera on Liberty had registered a movement, like a living creature, by a moonstone, and he tried, out of nervousness, to destroy the camera.

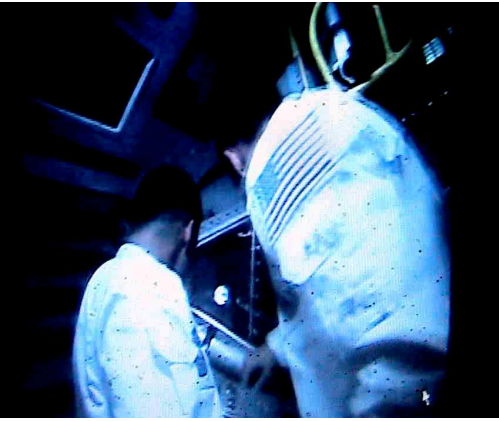

The assignment is completed, the crew abandoned and totally isolated from the Earth. They are overpowered by the aliens. The day before they looked upon the Earth from Liberty's window and regarded it as home, but now everything seems to be over. The only chance they have is to walk over to the still functioning Soviet lunar module and take off using that, back to Freedom.

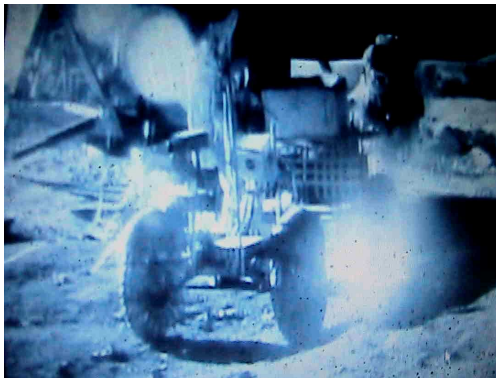

In the early evening Walker and Anderson left Liberty forever, they sat down in the lunar roving vehicle and drove back to the Soviet lunar module **Lunnig Korabl, LK**. On their way Walker destroyed the lunar roving vehicle because he was nervous and afraid and did not want his chest wound to contaminate the Earth. He was worried, he did not know if it was possible to return to Earth.



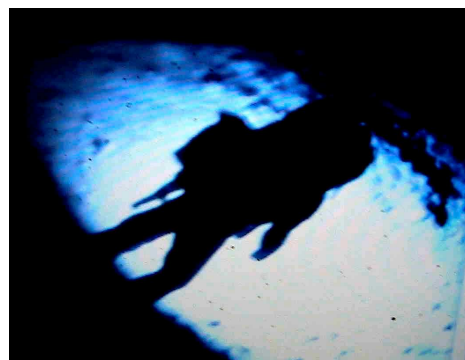
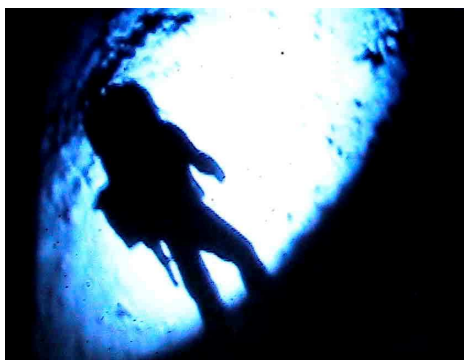
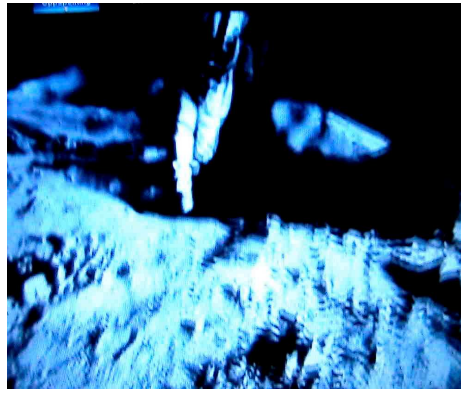
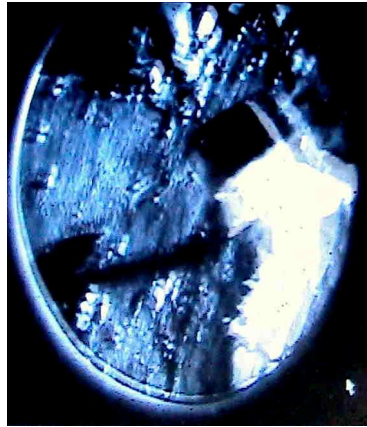
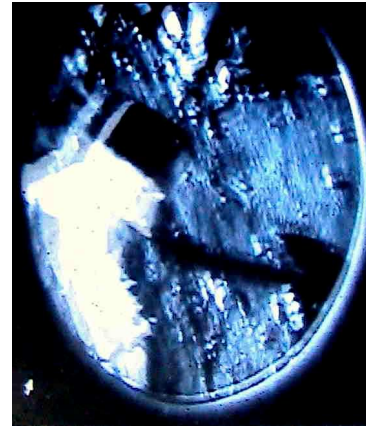
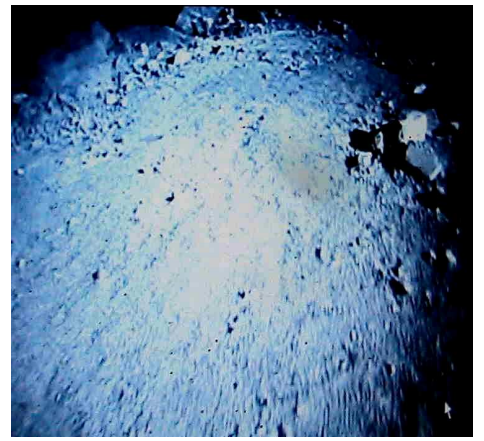
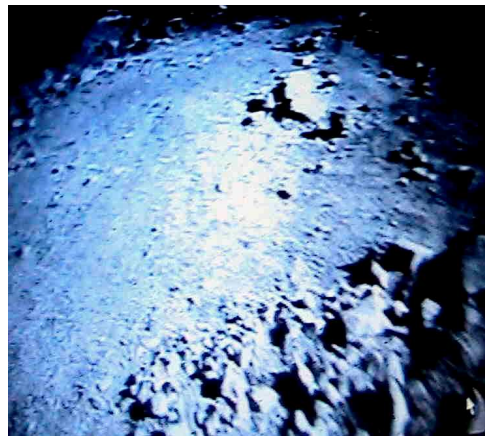
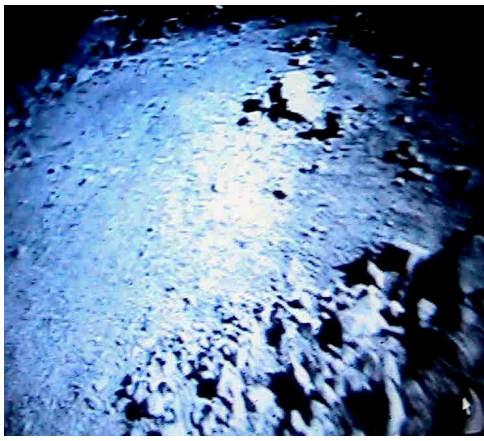

Walker walked ahead of Anderson; the aliens caught up with them and threw Walker into the crater where the dead Soviet cosmonaut lay untouched.



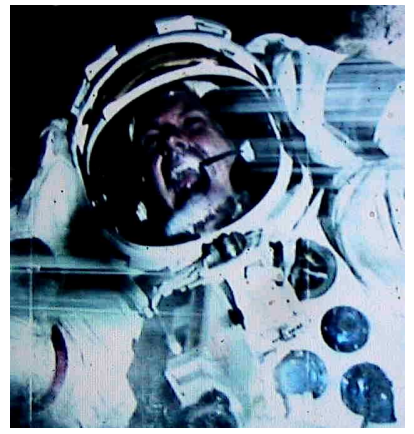

Anderson hurried after Walker to help him, but the aliens attacked him, too, which made him run faster to the Soviet lunar module.



Walker managed to leave the crater and hurried along to the module to catch up with Anderson. But the aliens caught him again and outside the module they killed him.





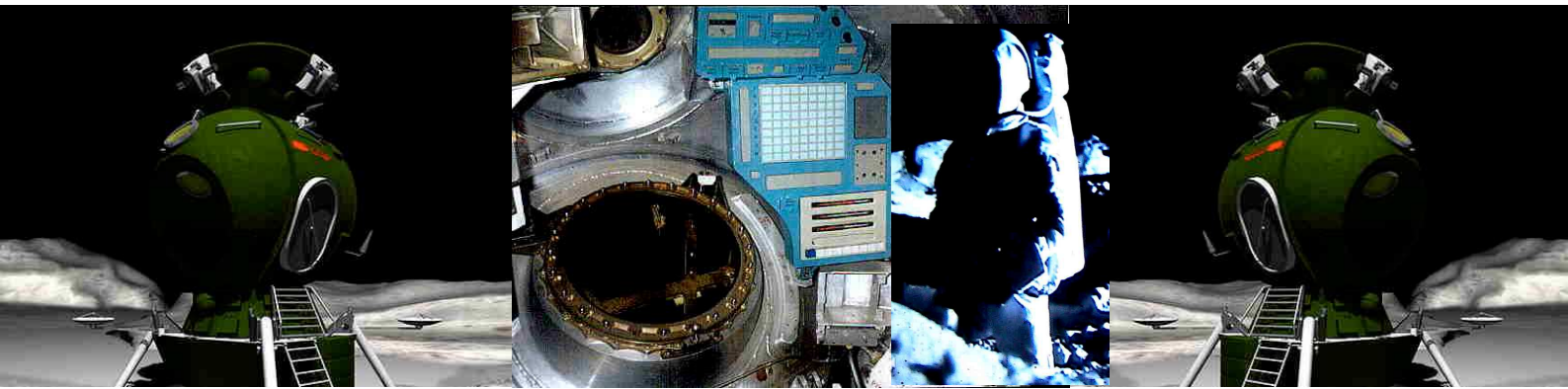

Anderson managed to enter the lunar module. He contacted the Soviet ground control who put him through to the American ground control in Vandenberg. USAF and its ground control said no to his return to Earth. The mother ship Freedom was also ordered not to dock with Anderson who was in the Soviet lunar module. The reason for this was that Anderson carried a disease and risked contamination if he returned. The Freedom astronaut Grey did not comply, he was prepared to carry out the docking. The lunar module took off from the Moon and entered the correct orbit around the Moon, probably assisted by the Soviet ground control.

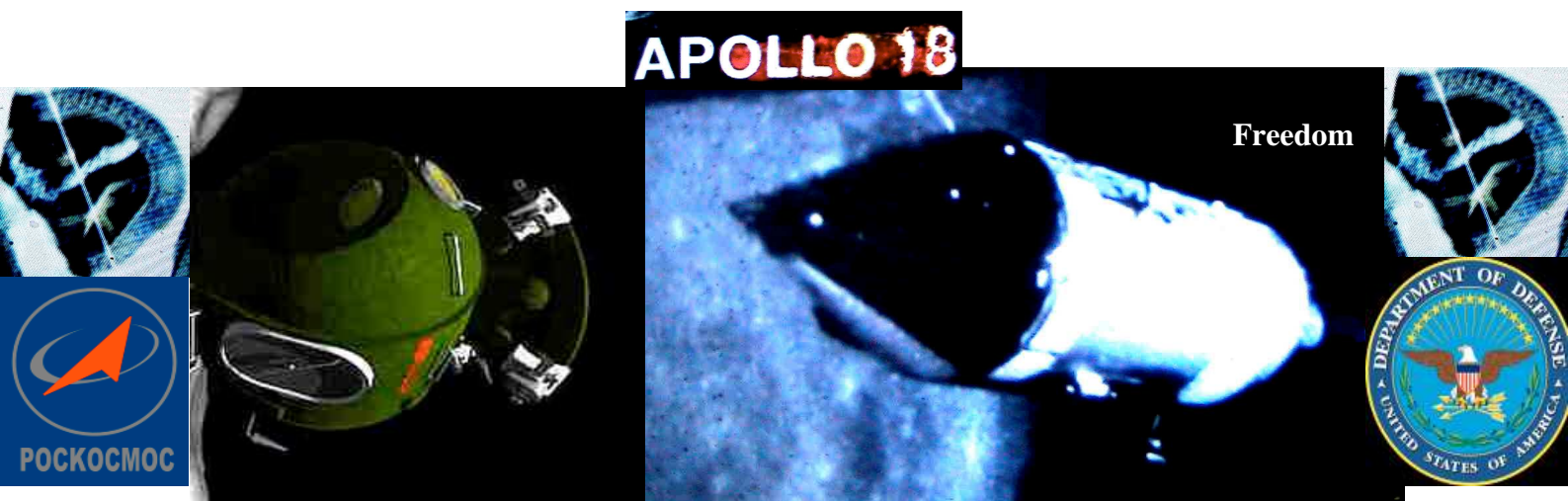

The docking was under way and the Soviet ground control was probably in touch with Freedom. The problem was that some small aliens were also with Anderson, creating some kind of dangerous illness. It affected Anderson fairly quickly and in that way he finally lost control of the module which, at high speed, crashed into Freedom.

This top-secret military mission by Apollo-18 was shown as science fiction film on September 2, 2011, in the US, Canada and Great Britain. Behind science fiction is a reality consisting of documents which leaked from the main source. The film tried to render the origins, based on documents, films and pictures.

Apollo-18's secret assignment was real, but unfortunately tragic. Behind the film production were also experts. They did not, of course, come from NASA, NASA had nothing to do with this secret, inhuman DOD mission.

I have always claimed, and I still do today, that you cannot accomplish something without leaving traces behind. If we analyse Apollo-18's mission, we find three strong clues to why the mission ended like it did:

- 1 Apollo-18's lunar module Liberty landed in the area where the Soviet lunar module had also touched down; a dead cosmonaut was found.
- 2 The crew immediately moved towards the crater with the dead cosmonaut. They found footprints from animal and human being and also a bloody lunar module, still functioning.
- 3 The docking between the American mother ship and the Soviet lunar module would have ended well.

The still functioning Soviet lunar module is the most important clue of these three. Walker and Anderson found a perfectly working module which might mean that the lunar landing took place at some time between summer and autumn, 1974. A lunar module like that, called **Luna 23** was launched on October, 28, 1974, from Baikonur Cosmodrome and landed at southern **Mare Crisium** on November 6, at 5.37 a.m. It completed its mission on November 9.

Let us have a closer look at Luna 23's space flight and its role in this context.



# Soyuz 7K-LOK/Luna 23

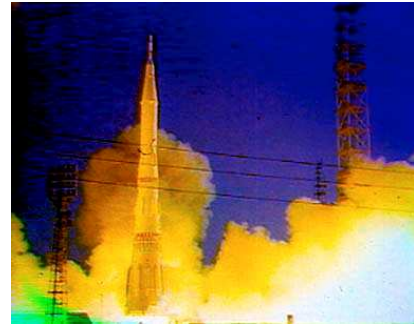

On October 28, 1974, Soyuz 7K-LOK/Luna 23, probably started from Tiuratam Cosmodrome, but officially from Baikonur Cosmodrome, two unknown cosmonauts constituted the crew. The take-off went according to plans. The goal was the Moon and a touch-down at the southern part of Mare Crisium.



Towards the Moon



Orbiting the Moon

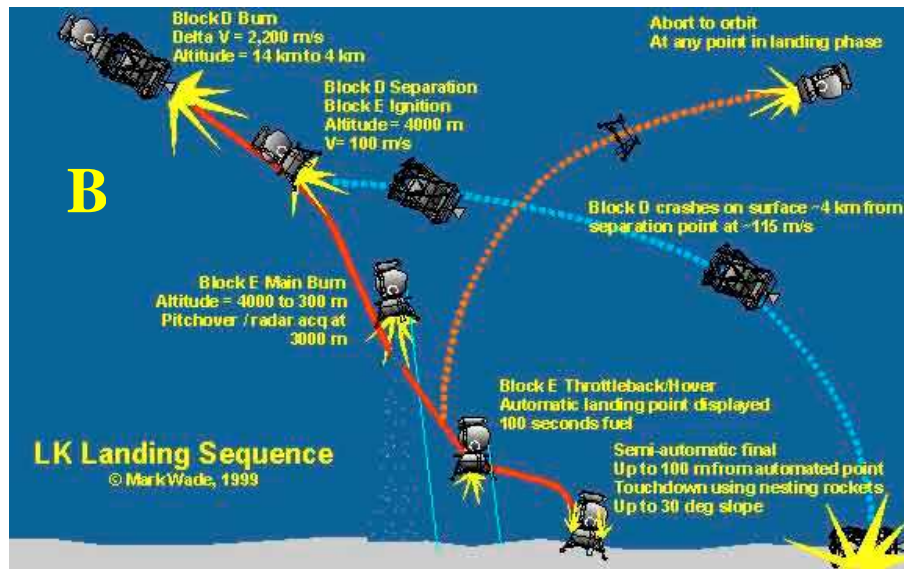
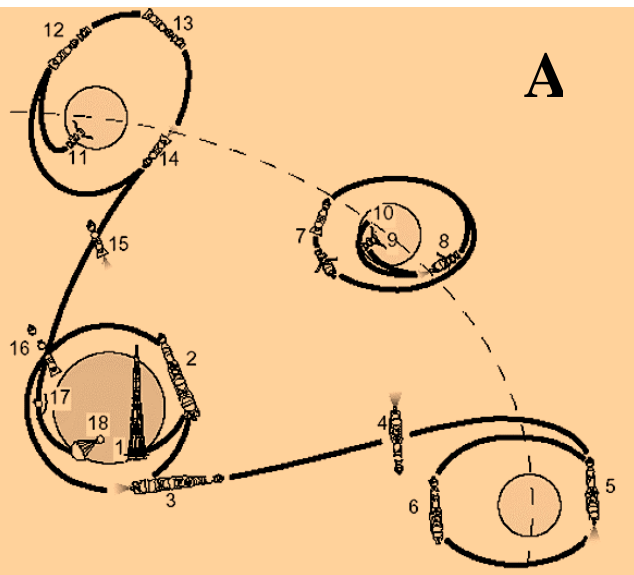

Picture **A**, 1-18, illustrates Soyuz 7K-LOK's flight to the Moon, its landing and the return flight to Earth. 1-4 depict the take-off from Earth, 5-6 illustrate the mother ship LOK orbiting the Moon, 7-10 give us an idea of the separation between LOK and the lunar module LK and the touch-down. 11-13 illustrate the take-off from the Moon and the docking. 14-18, finally, show the return flight and the touch-down.

Picture **B** is an illustration of LK's touch-down on the surface of the Moon. LK has two parts, block D and E above. The first block is used for a forceful reduction of speed. It is then separated and heads for the ground, while LK makes a soft touch-down on the surface of the Moon. After take-off the lower part of LK remains on the Moon. Eventually the docking takes place and then back to Earth.

After LK has landed, the separated block D is not very far away according to picture **B**.



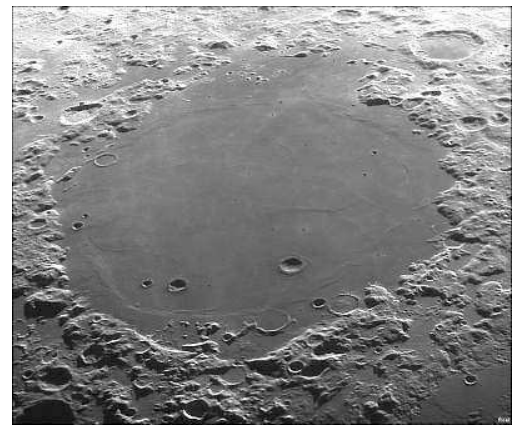
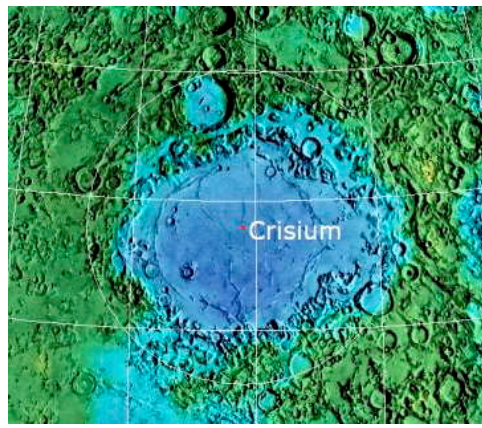
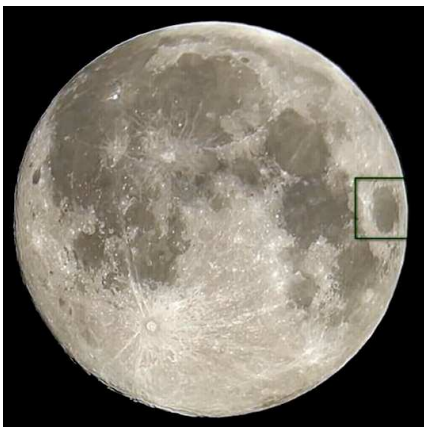

If we take a closer look at this picture of the Moon we clearly see the squared Mare Crisium area. It is situated in a special area on the border between the front and reverse side of the Moon.

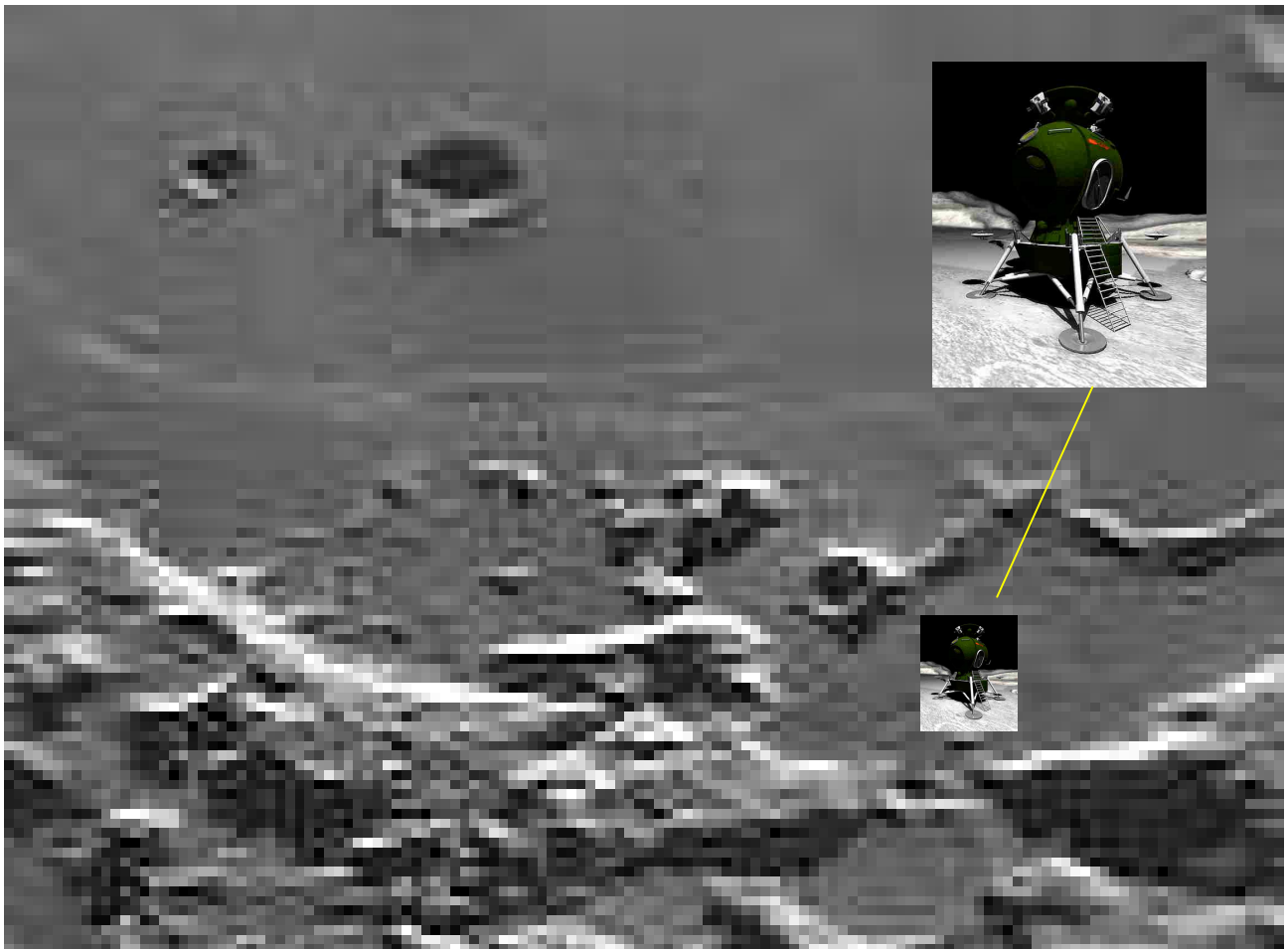
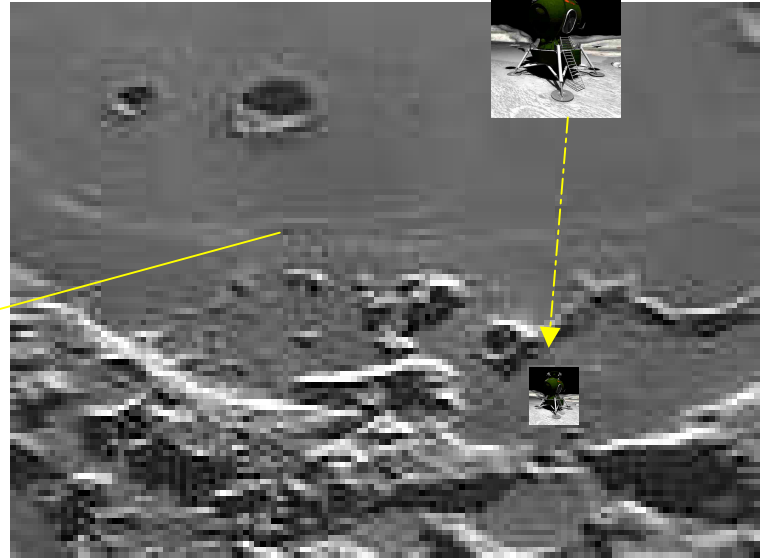
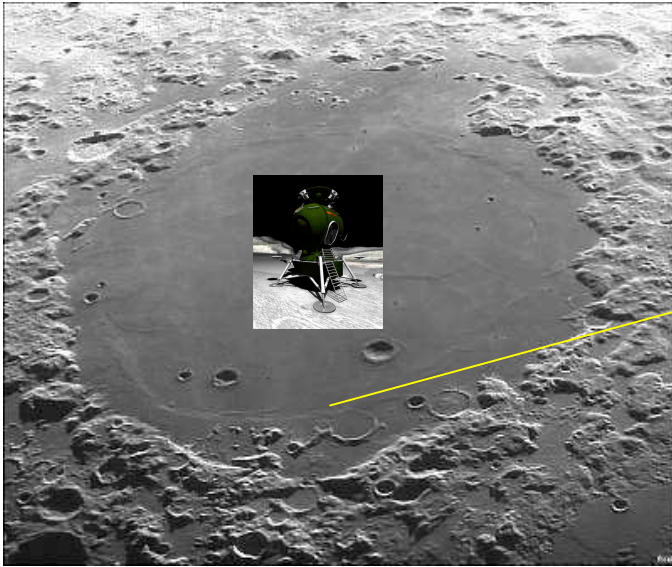

On November 6, 1974, at 5.31 a.m. **Lunnig Korabl, LK/Luna 23** landed in southern Mare Crisium carrying one cosmonaut.





LK on the Moon, Mare Crisium

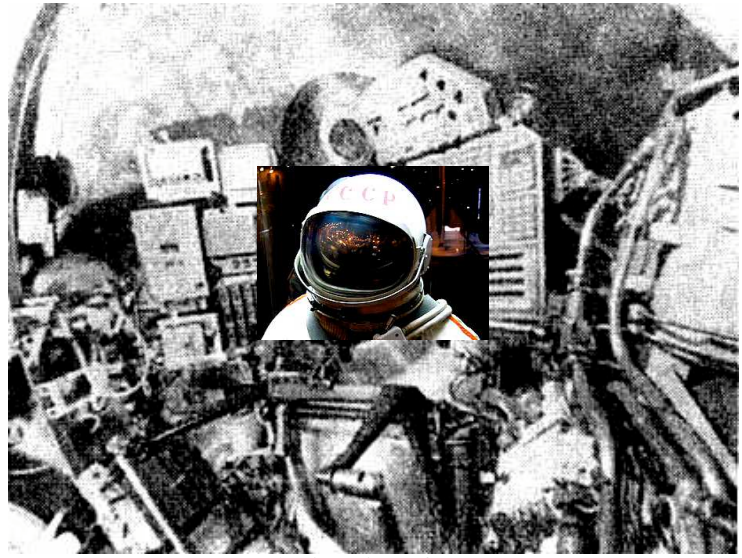

The interior of LK

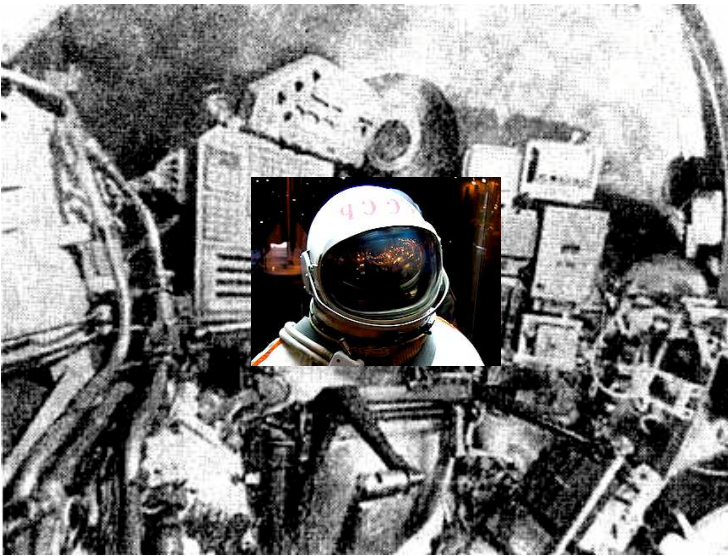

The interior of LK

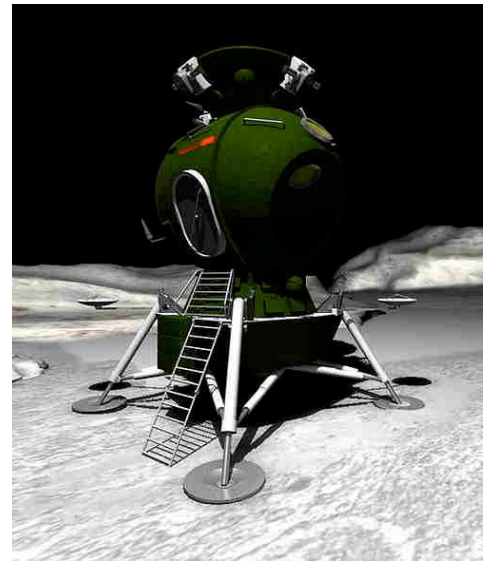

LK on the Moon, Mare Crisium

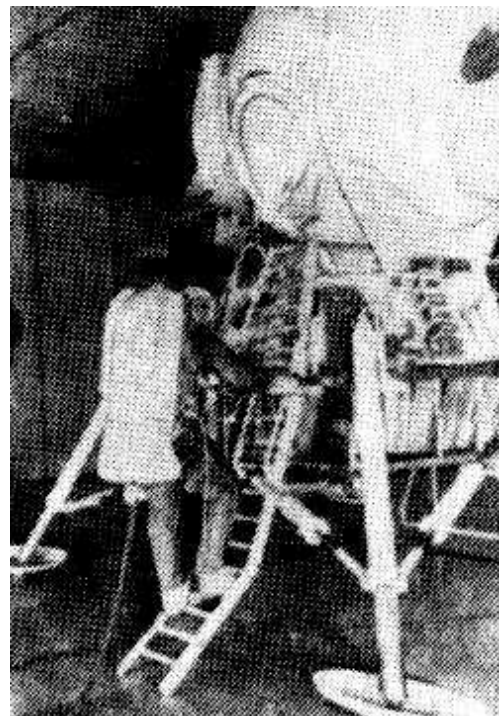

The cosmonaut on his way out of the lunar module LK.

After having followed Walker's and Anderson's description of the situation outside the Liberty area, how they had found a dead Soviet cosmonaut dressed in his spacesuit in a crater, the fact that the lunar module was blood-stained inside, we must ask some questions. It is obvious that the blood did not come from the dead cosmonaut. What had happened?



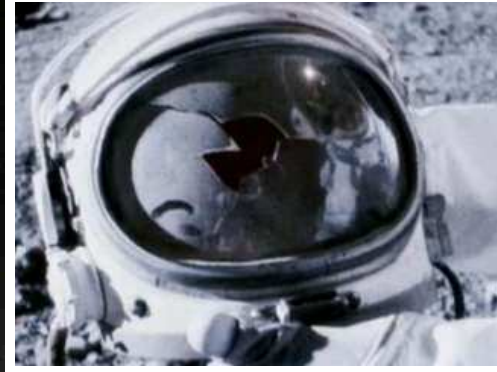
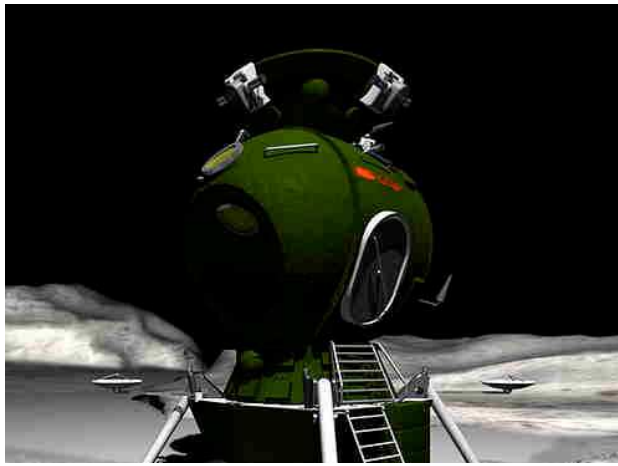

The Soviet cosmonaut had left LK and was a couple of metres outside the lunar module. Suddenly a couple of aliens appeared and wanted to talk to him. Most likely the cosmonaut suffered a panic attack, was scared and returned to LK. Some alien(s) followed him all the way into LK. The cosmonaut grabbed a weapon and killed one of the aliens. In that way LK got its interior blood stains. The next day he went out again. The aliens seized him and threw him into the nearby crater, where he died. He was certainly communicating with the ground control, they knew about what had happened. Moreover, the lunar module was equipped with cameras which sent the pictures in real time to the ground control in YEVPATORIYA.

The aliens just wanted to tell him that his landing site was a no-go area. The Soviet Union was not permitted to land there, he needed to leave the Moon as soon as possible. The cosmonaut had probably visited a moon station belonging to the aliens without permission.

We can ask: is it possible to allow a single cosmonaut to land on the Moon without any knowledge about the planet's inhabitants? The cosmonaut suffered a mental breakdown upon catching sight of the aliens. He surely received strange answers from the ground control when he asked whether the creatures were animals. We know that the space organisation of the former Soviet Union was almost 100% military activities. Regardless of his assignment, the Soviet cosmonaut was nothing compared to the superior aliens.

What happened to the second cosmonaut who was in the mother ship LOK, orbiting the Moon? Did he return alone to the Earth? Did the rocket engine work when LOK tried to leave the gravity of the Moon? The mother ship's life expectancy was 13 weeks. According to records, the contact between Luna 23 and the ground control was cut on November 9, 1974, when Luna 23/LOK was still orbiting the Moon. Probably, neither the ground control nor the cosmonaut was able to start the rocket engine, so the mother ship LOK remained orbiting the Moon, with any contact with the ground control.

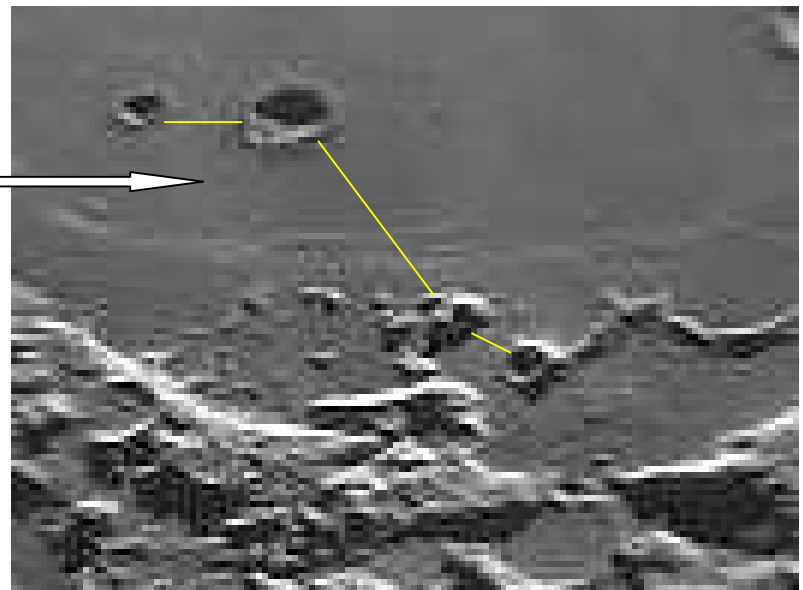
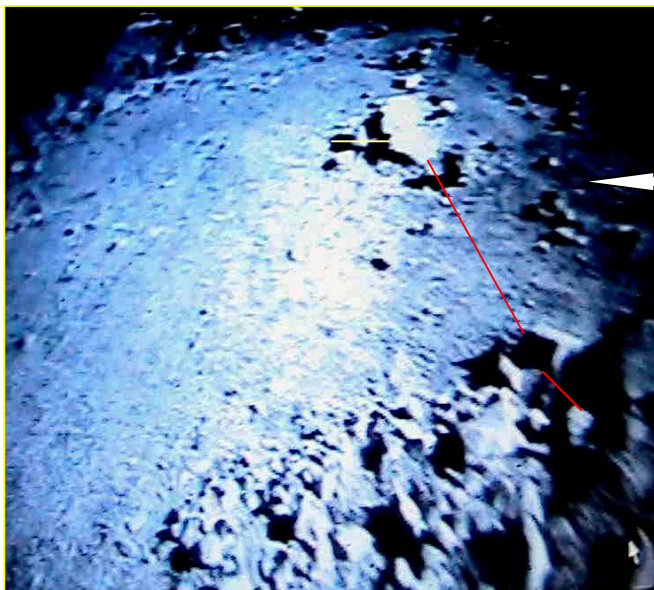

**Apollo-18** landing site – Liberty  
In southern Mare Crisium

**Lunnig Korabl, LK/Luna 23** landing site  
in southern Mare Crisium

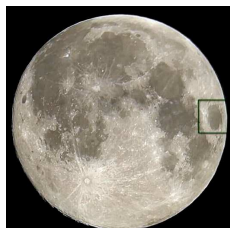
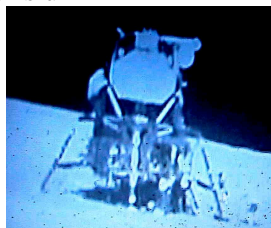



# Southern Mare Crisium

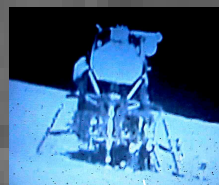

Liberty



Astronaut Walker

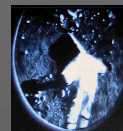

Cosmonaut



Lunnig Korabl", LK  
Luna 23

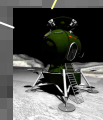

## Apollo-18 - Soyuz 7K-LOK/Luna 23

According to documents, Apollo-18's classified mission took place at the southern part of Mare Crisium, on the border between the front and reverse side of the Moon. This is the bloodiest event we know about in modern space history. Everything is secret, hidden away in the dark world, typical worldly madness. The USAF astronauts knew nothing about the true assignment. John Grey named his Apollo mother ship **Freedom**, while Benjamin Anderson and Nathan Walker named the lunar module **Liberty**. As far as I understand, neither Freedom nor Liberty is a symbol of warfare and killing. Alan Shepard's Mercury-3 was called **Freedom**, and Virgil Grissom's Mercury-4 was baptized **Liberty Bell** by Grissom himself. I am fairly certain that the Apollo-18 crew were thinking of Shepard and Grissom before they went to the Moon. Had NASA been responsible, I am sure the astronauts would have returned since none of them had a contagious disease. NASA would have quarantined the astronauts after touch-down, as was done with the Apollo-11 crew. All the world knows that the military establishment is a death-tool, it does not care about its soldiers. How important were the lives of three human beings in this context? Nothing. But the ground control in YEVPATORIYA in the Soviet Union helped Anderson and Grey to return to the Earth, which is a credit for the former Soviet Union in this context. The Soviets honoured the co-operation. NASA certainly knew about Apollo-18's secret moon flight, but they have no obligation to tell the world about the military secret activities on the Moon.

During the 1970's the space co-operation between the US and the Soviet Union started to grow, which gave as a result the Apollo-Soyuz TP, (Test Project/docking) on July 15, 1975. This is one more, strong clue, since Walker and Anderson immediately found the dead cosmonaut and the lunar module. This co-operation continues today.

When it comes to aliens, it is worth noticing that they can exist in any building, in any spaceship, invisible because of a change of the level of frequency. They did this in connection with Liberty and LK. They can create illnesses and various wounds on human bodies, invisible to us on any individual. More info at *The Forth Pyramid Which Disappeared*, page 57.

Apollo-18's original assignment can be summarised thus: The Soviet Union probably contacted the US and told them what had happened. They asked the Americans to investigate what had really happened in southern Mare Crisium. The Soviet Union provided the Americans with detailed information about the landing. This is why the Apollo-18 crew immediately could find the LK module. This is what we can find out about the Apollo-18 moon flight in December, 1974. We can add that the American astronauts were prepared to meet the aliens, but these were tough because Liberty landed in the same area as Luna 23.



The next DOD mission would have been Apollo 19, a soft landing outside the Izsak crater D on the far side of the Moon, close to a triangular object. This was an armed mission, prepared for self-defence, should such a situation occur.

# Apollo-19 USAF/DOD

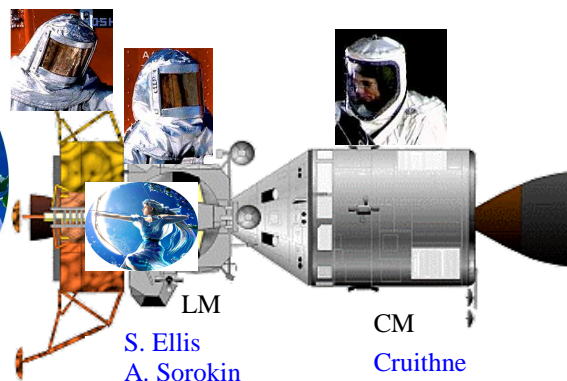
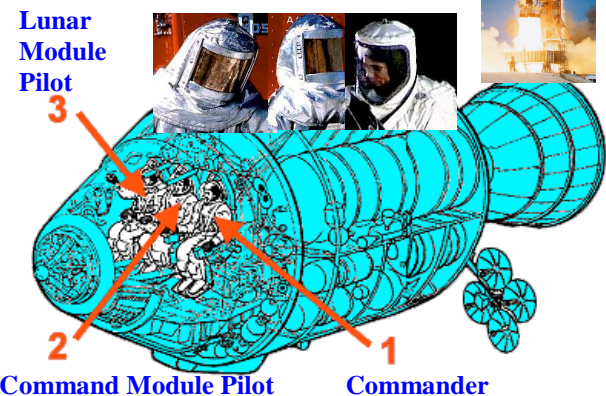

Stephanie Ellis 1, Aleksey Sorokin 3, Cruithne 2  
**Apollo-19, USAF/DOD, Dec 1975**

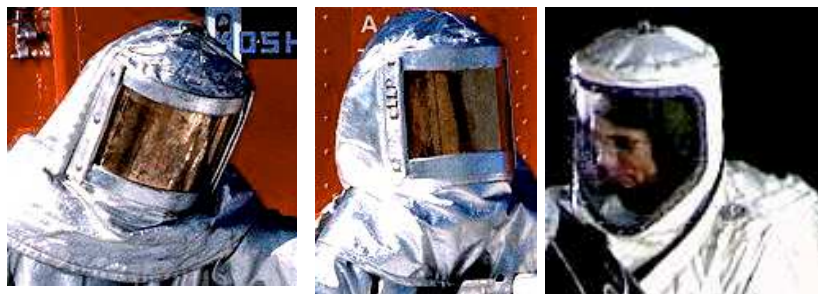
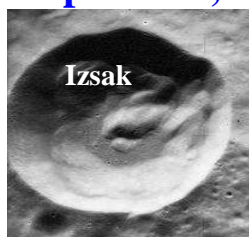

Stephanie Ellis, Aleksey Sorokin and Cruithne

## The Apollo-19 Crew



Stephanie Ellis  
1946-1975



Aleksey Sorokin  
1931-1975 (1976)

Apollo-19 was a DOD mission launched from Vandenberg Air Force Base in California some time in December, 1975. According to William Rutledge its assignment was to land on the Izsak crater on the far side of the Moon. The crew may have been armed. One of the Apollo-20 astronauts, William Rutledge, has revealed the Apollo-19 secret mission. According to him Apollo-19 had an accident and the crew was lost in a collision. This may mean that Apollo-19 was annihilated by the aliens when it left the Earth on its way to the Moon. One member of the crew, according to Rutledge, was called **Cruithne**, but, also according to Rutledge, the original crew consisted of **Stephanie Ellis, Aleksey Sorokin and John Swigert**. Swigert died from cancer in 1982 and was replaced by Cruithne in 1975. Sorokin was declared dead in the Soviet Union on January 11, 1976. This was how the DOD mission was terminated in the 1970's. Stephanie Ellis was the first American woman in space, but she was not the first commander of Apollo-19. She was also declared dead in late 1975. Note that the Apollo-19 mission was top secret, it cannot be officially confirmed.



Stephanie Ellis  
Apollo-19



Apollo-19



Aleksey Sorokin  
Apollo-19



The next flight to the Moon, the very last, was to be accomplished by Apollo-20. First of all I will analyse Apollo-20's emblem, a symbol of Apollo-20's mission to the moon.

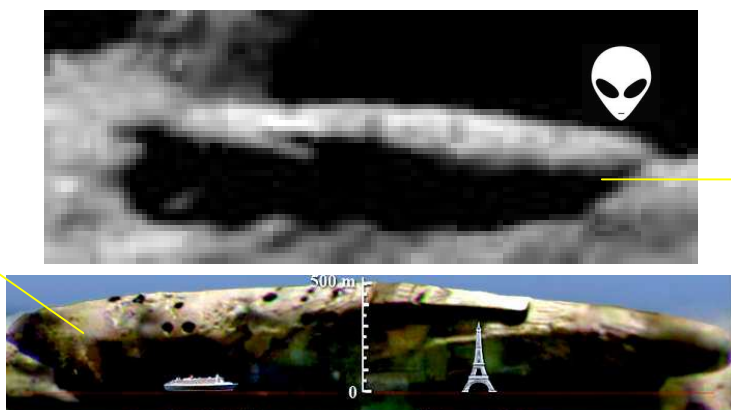
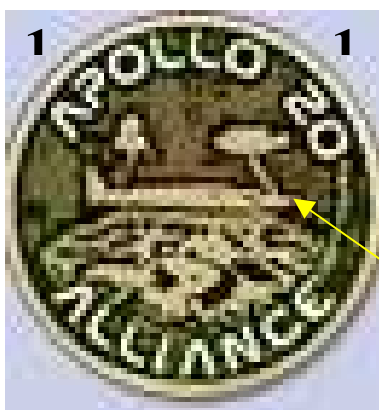
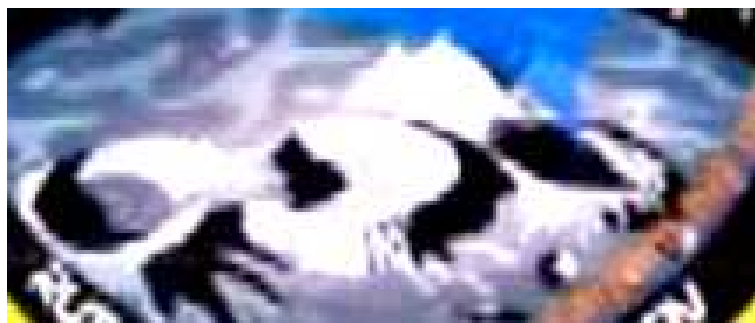

After Apollo-19's failure in 1975, the breakthrough came for spaceflights to the Moon. This was probably arranged by the aliens' boss here on Earth, Jarod 1. He made it possible to carry out the last flight to the Moon. The result can clearly be seen on Apollo-20's program emblem. This is the most remarkable, the best and the clearest space emblem after 1950.

On the emblem we can see a large crater with round buildings where there seems to be activities. This is illustrated by creatures among the buildings. Above the crater is a flying object with a double message. One message has the form of an airplane indicating that the Apollo-20 crew (Rutledge and Snyder) are USAF astronauts. The second message is a flying cigar-shaped spaceship, four kilometres in length, belonging to the Alliance (the aliens).

Above the flying spaceship are a lunar module and an Apollo command module. Both can communicate with the cigar-shaped spaceship. This tells us that the crater which Apollo-20 is about to visit is at the far end of the Moon, since communication between the spaceship and the ground control is impossible as soon as Apollo is on the far side of the Moon. This applies to both the Soviet/YEVPATORIYA and the USA/Vandenberg. The **alliance** is the host of this spaceflight.

The third member of the crew is the Soviet cosmonaut Alexey Leonov. This means that the Soviet Union could also carry out a flight to the Moon and a touch-down. Leonov was the elected cosmonaut for this spaceflight with Apollo-20.

**Emblem 1** represents the Alliance, the aliens, and **emblem 2** represents the Earth. The Soviet/Soyuz started its spaceflight on August 9, 1976. The USA/Apollo took off on August 16, 1976. Since the Soviets started as number one, let me begin with that.



# Soyuz 7K-LOK/Luna 24



On August 9, 1976, Soyuz 7K-LOK/Luna 24 took off, probably from Tiuratam Cosmodrome, officially from Baikonur Cosmodrome with two unknown cosmonauts on board. The start went according to plans. The aim of the flight was to accomplish a landing on the Moon in the southern part of Mare Crisium and a touchdown close to LK/Luna 23.



On August 11, 1976, Soyuz 7K-LOK/Luna 24 was on its way to the Moon.



On August 13, 1976, at 11.11 p.m. Soyuz 7K-LOK/Luna 24 entered its orbit around the Moon. Vast amounts of pictures were taken of both sides of the Moon.

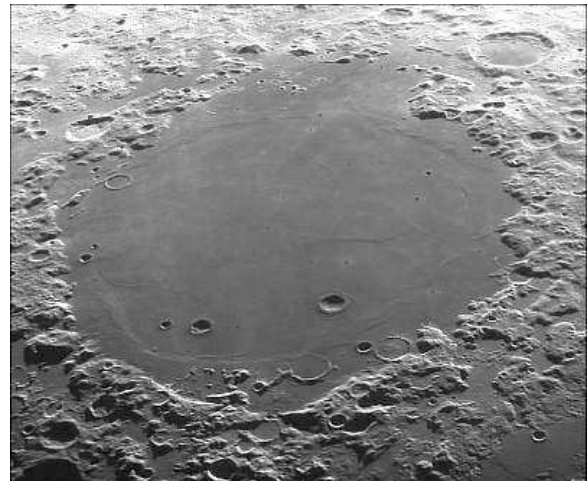
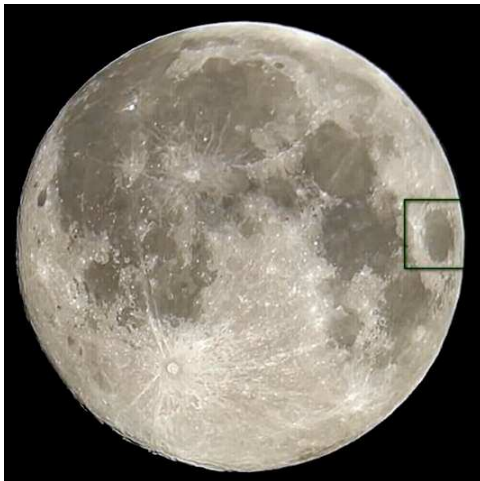

The Mare Crisium area is on the border between the front and far side of the Moon. Soyuz 7K-LOK/Luna 23 and Apollo-18 had landed there before, in 1974.

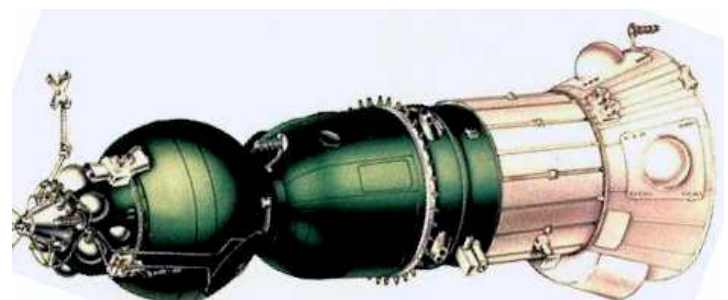
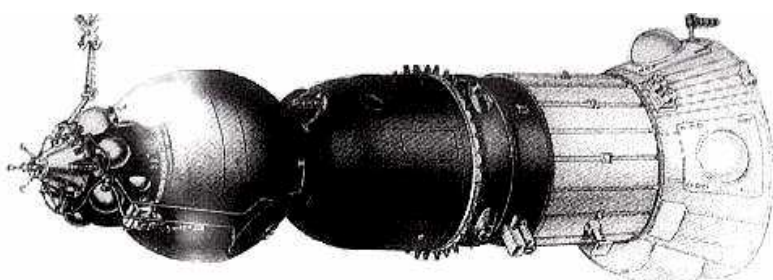

# Soyuz 7K-LOK/Luna 24



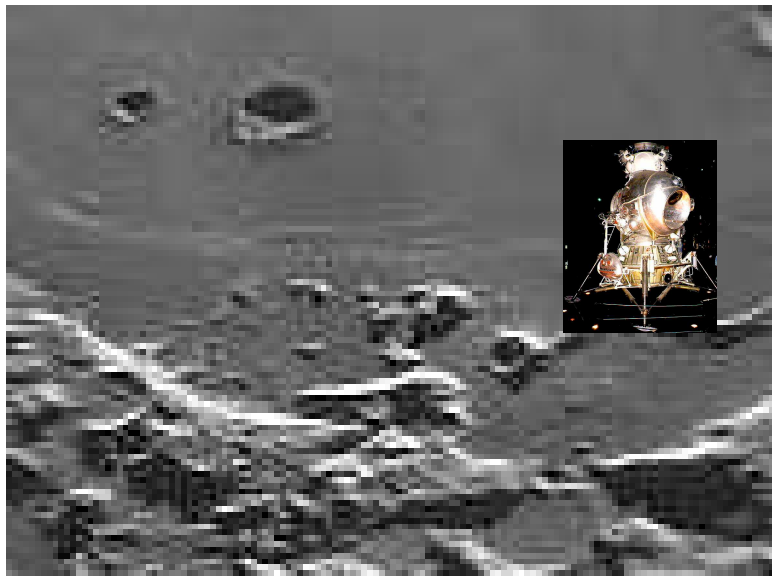
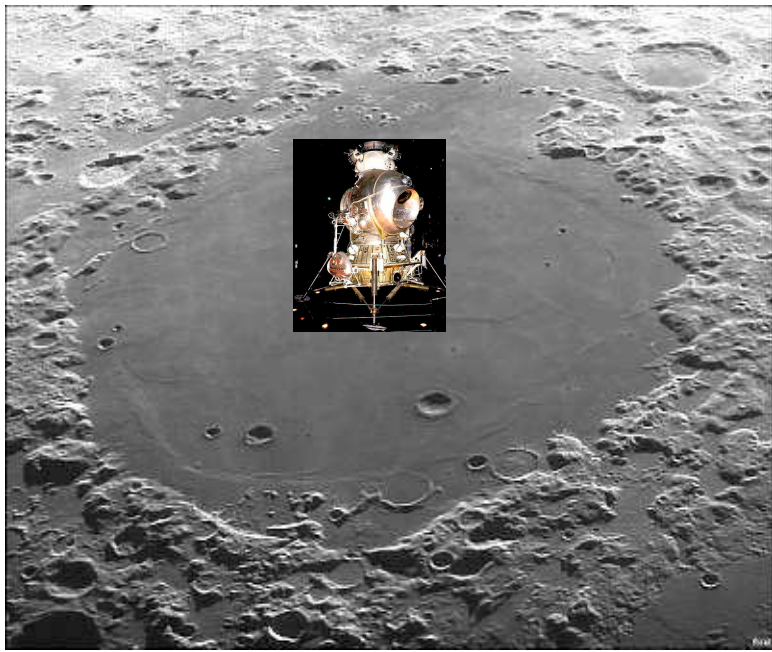

Landing site for **Lunnig Korabl, LK/Luna 24**  
Southern Mare Crisium

## Southern Mare Crisium

Apollo-18

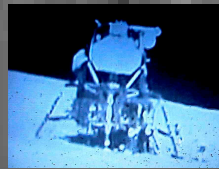

Liberty, 1974



Lunnig Korabl", LK  
Luna 23, 1974



Lunnig Korabl", LK  
Luna 24, 1976

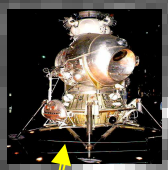
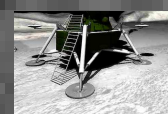
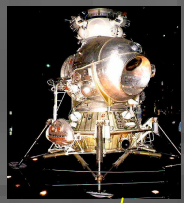

**Soyuz 7K-LOK/Luna 24**

On August 18, 1976, at 6.36 a.m., **Lunnig Korabl, LK/Luna 24** touched down on southern Mare Crisium carrying one cosmonaut. The landing was perfect and LK/Luna 24 touched down 500 metres from the lower part of LK/Luna 23. The Soviets could choose where to land and again they chose southern Mare Crisium, probably because they wanted to get rid of the earlier failure, the two dead individuals outside the lunar module LK: one American and one Soviet cosmonaut co-operating with the USAF.

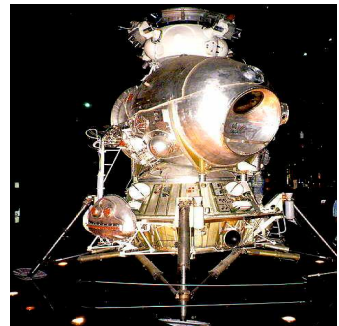
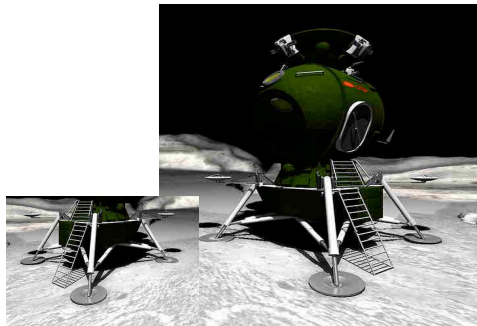
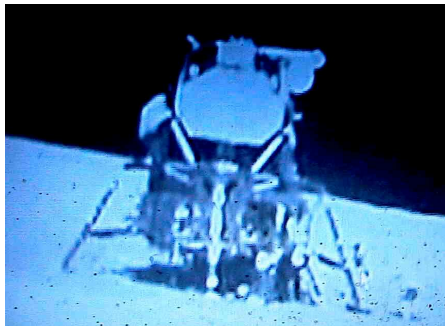



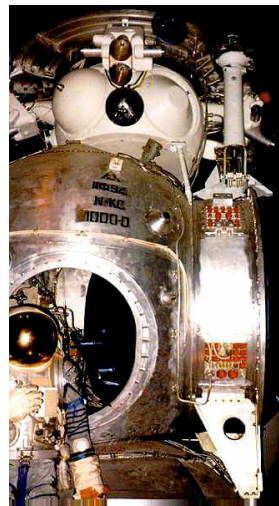
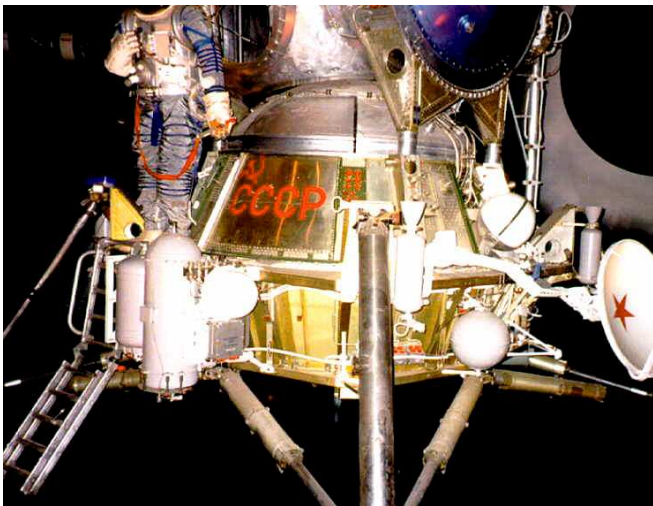
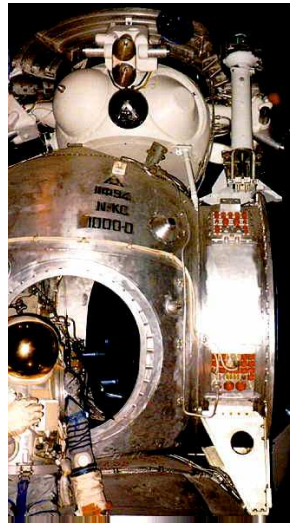
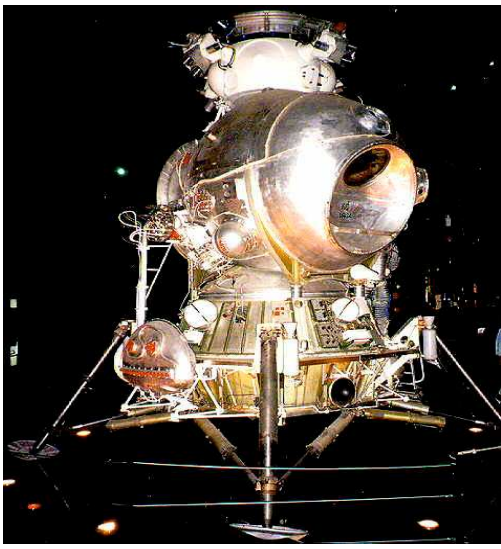

The unknown cosmonaut climbs out of his lunar module some hours after landing. He was alone, no aliens turned up. He could move about freely, all the time in contact with the ground control, the space ship LOK and the second unknown cosmonaut.

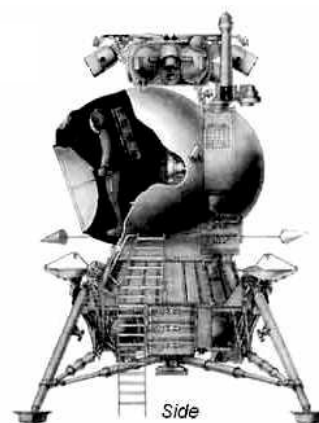
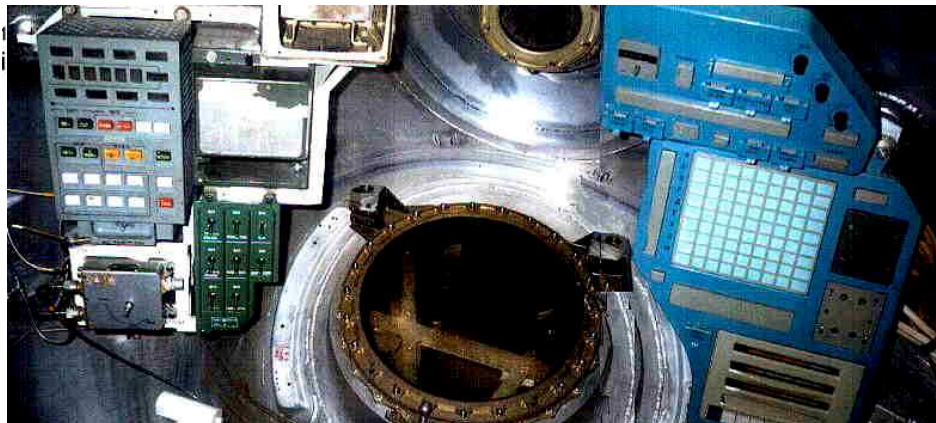
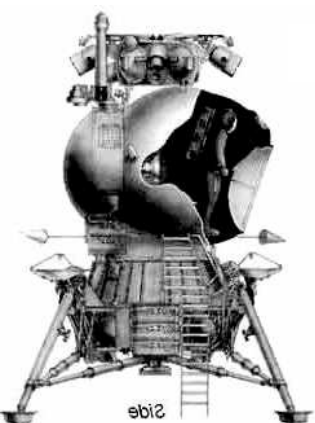



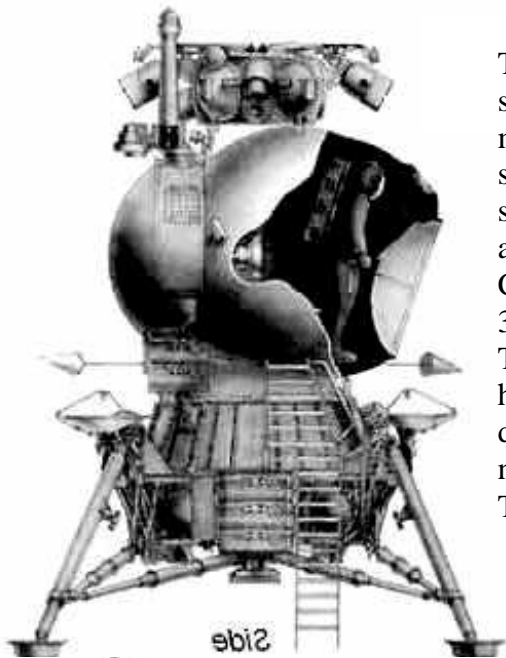

The pictures clearly demonstrate that the Soviet lunar module was built for one single cosmonaut. Imagine standing there all alone among aliens or totally alone at Mare Crisium with a diameter of 3760 kilometres.

This is not something for a human being, this lunar module is perfect for a robot, managed by the ground control. This is my own view.

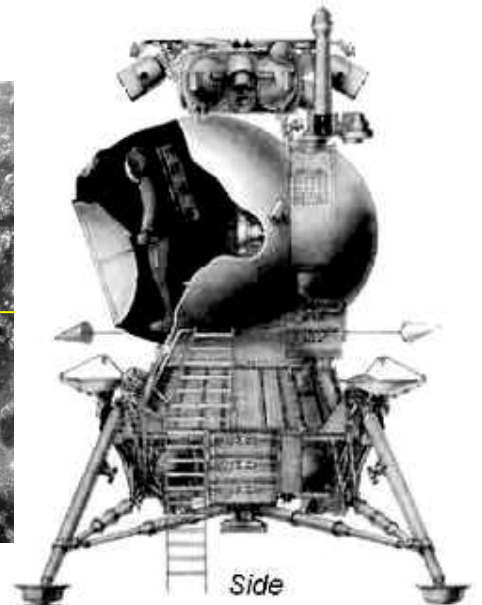
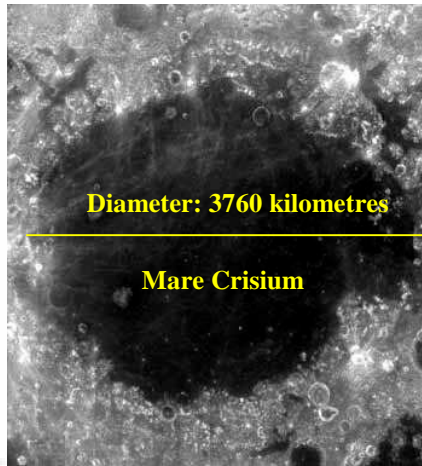
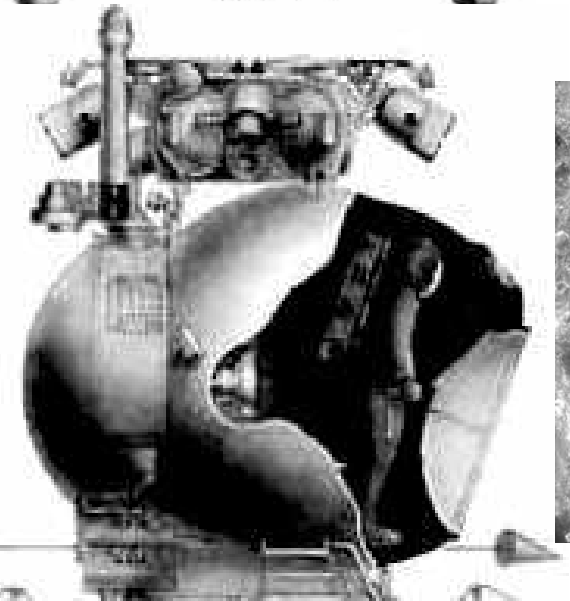
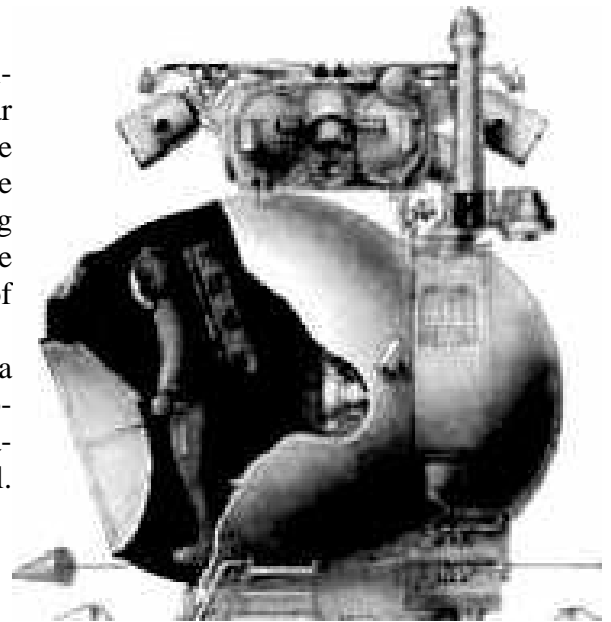

## Southern Mare Crisium

The Soviet cosmonaut



Walker, American USAF astronaut

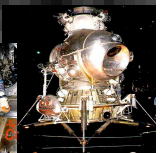
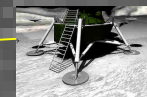
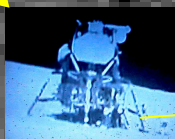



The new cosmonaut's assignment, to my understanding, was to clean up after the 1974 bloodbath in southern Mare Crisium, above all to somehow get rid of the dead bodies and check Liberty inside and out to remove all traces of the Americans. Walking around alone on a blood-stained battlefield was not an easy assignment. I do not know to what extent he was prepared, but he did not know the full truth. The most probable scenario was that he, after the landing, received further information via the ground control. A strong feeling tells me that the cosmonaut was struck by some mental problems connected to his assignment. Imagine being totally alone on the Moon with dead bodies from the Earth, bodies no-one has ever heard about and suddenly being ordered to deal with them, to bury them or hide them from view in some other way. He communicated with the mother ship, it orbited the Moon and the other astronaut could follow the whole process, also via the ground control. It is probably that southern Marie Crisium has not changed in any way.

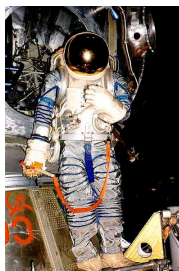

LK lands on August 18, at 6.36 a.m.

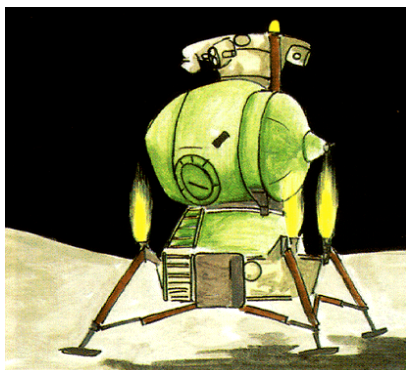

Cosmonaut assignment between around 1 and 4 p.m.

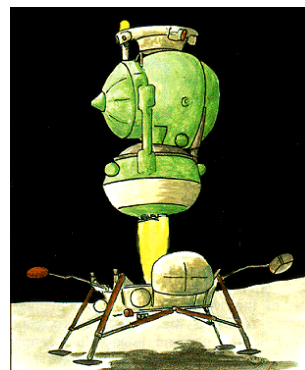

Take-off from the Moon, Mare Crisium, around 7 p.m..

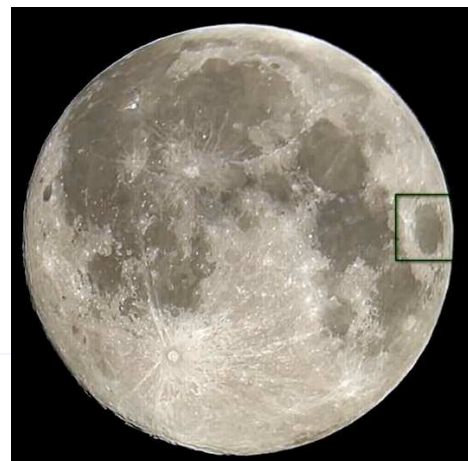
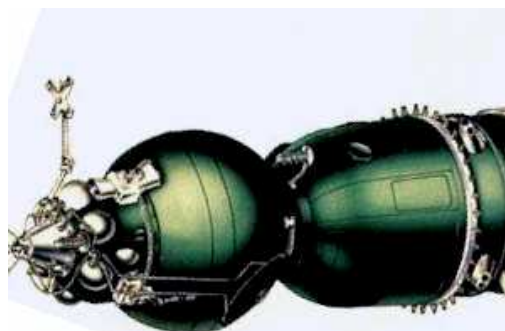

According to records, the start took place in the early evening followed by docking to the spaceship and as early as on August 19 at 5.25 a.m. **Soyuz 7K-LOK/Luna 24** left the Moon. On August 22 the capsule landed 200 kilometres south-east of Surgut. Was it a soft or a crash landing? Did the capsule enter the atmosphere at a correct angle or did it burn? How did the cosmonauts feel? Were they mentally disturbed, was it not possible to allow them to meet the world press? Something had happened, since the Soviet Union had nothing to say about the landing on the Moon and the flight. On August 24, 1976, the Soviet Union announced that the project **Soviet-Luna** finally had been cancelled.

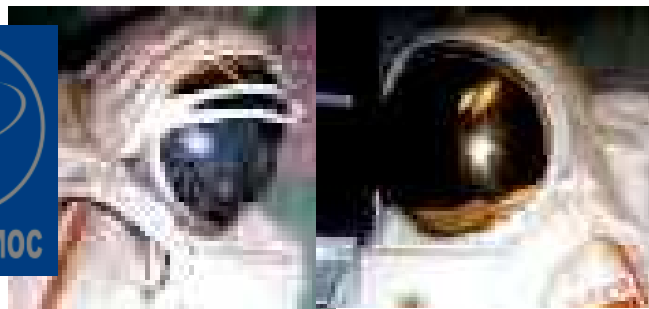

## Soyuz 7K-LOK/Luna 23

28/10/1974 09/11/1974

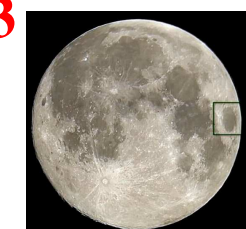
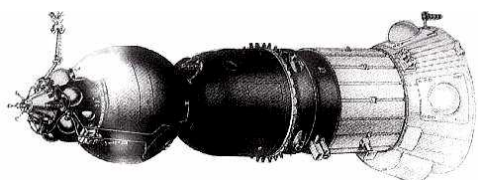

Southern Mare Crisium

## Soyuz 7K-LOK/Luna 24

09/08/1976 22/08/1976





# Apollo-20 USAF/DOD/Civilian

2007

2007

## Apollo-20

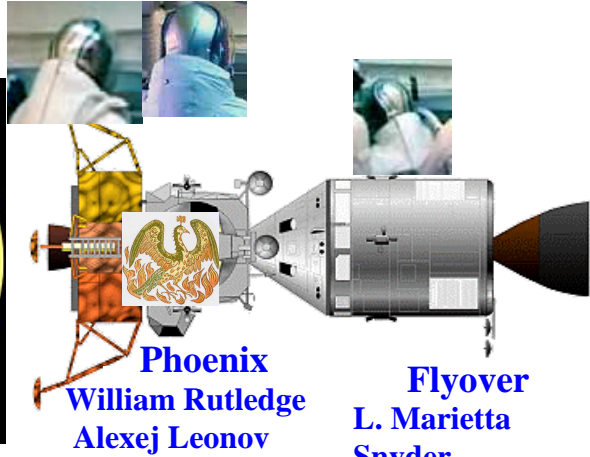

**Phoenix**  
William Rutledge  
Alexej Leonov

**Flyover**  
L. Marietta  
Snyder

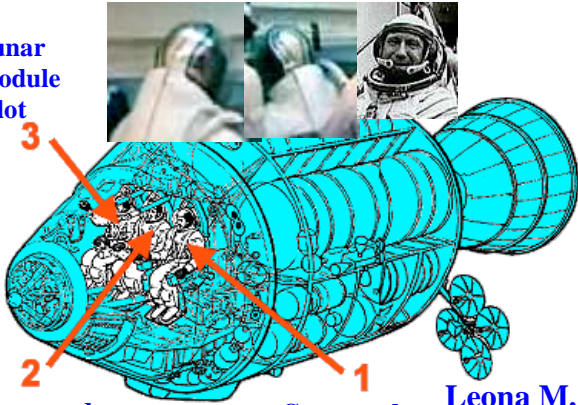

**Lunar  
Module  
Pilot**

3

**Command  
Module  
Pilot**

2

**Commander**

**Leona M. Snyder 2, William Rutledge 1, Alexey Leonov 3  
Apollo-20, USAF/DOD/Civilian, 1976-08-16**

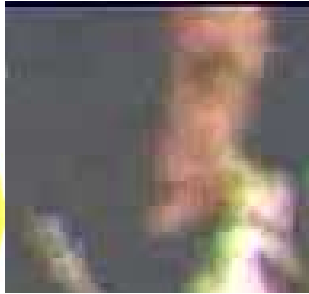

The Apollo-20 crew: William Rutledge, Leona Snyder, Alexey Leonov



Apollo-20 crew: William Rutledge, Leona Snyder, Alexey Leonov



Astronauts Rutledge, Snyder and Leonov enter the Apollo capsule assisted by staff from NASA and Rockwell Corp. The astronauts are prepared for the last flight to the Moon. (The USAF pilot William Rutledge and Leona Marietta Snyder worked for the Bell Laboratory,)

William Rutledge revealed Apollo-20's top secret mission in 2007





Astronaut Snyder is the last person to enter the Apollo capsule assisted by staff from NASA and Rockwell Corp. The astronauts are prepared for the last flight to the Moon, which lasted one week. (16/08/76 – 23/08/76).

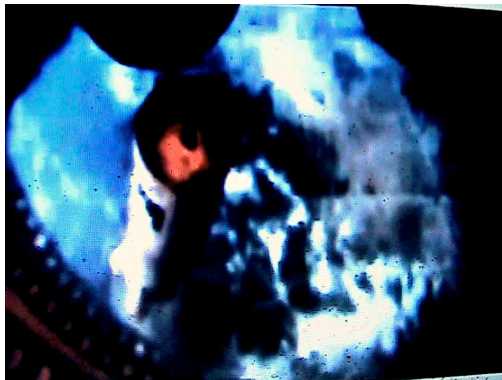

Apollo-20 was a DOD mission, perhaps more civilian than DOD, and started from Vandenberg Air Force Base in California early in the morning on August 16, 1976. Staff confirm that the mission was partly connected to NASA.



Apollo-20 leaves the Earth on its way to the Moon in order to perform, in co-operation with aliens, a moon landing outside the Izsak D crater on the far side of the Moon.



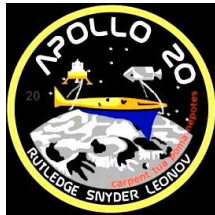

In the command module **FLYOVER** Leona M Snyder was alone and handled communication between ground control (YEVPATORIYA for the Soviet Union and CapCom, Charles Peter Conrad and James Irwin in Vandenberg for the USA), the lunar module Phoenix and the aliens. She was the hub of all contacts and a very important part of the mission. She also took lots of pictures, especially of the far side of the Moon above the Izsak D-Delporte area, where the lunar module **Phoenix** landed.

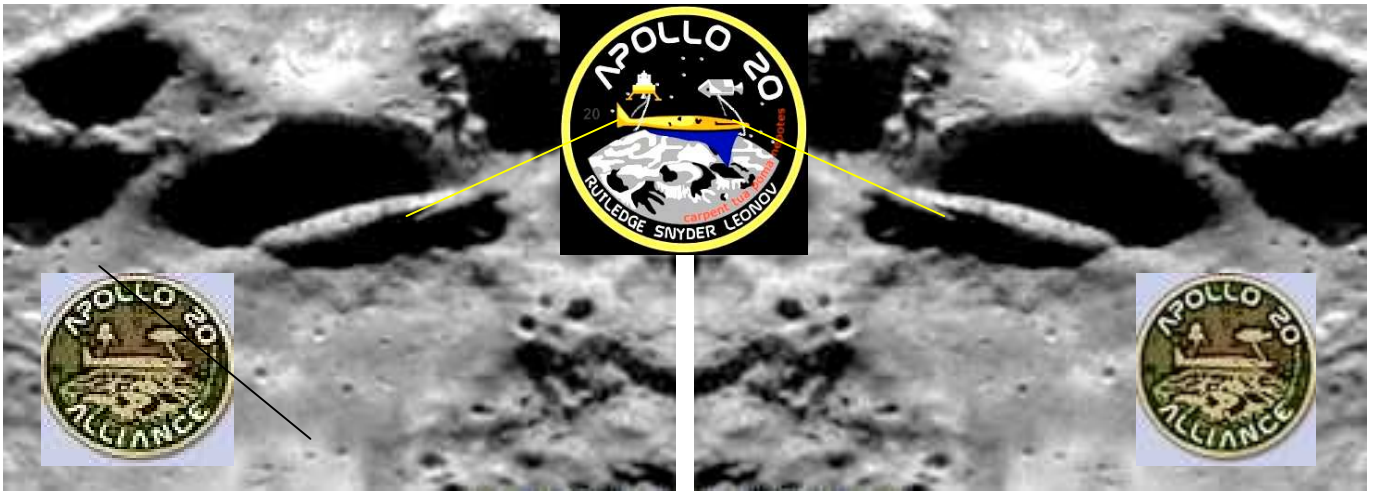
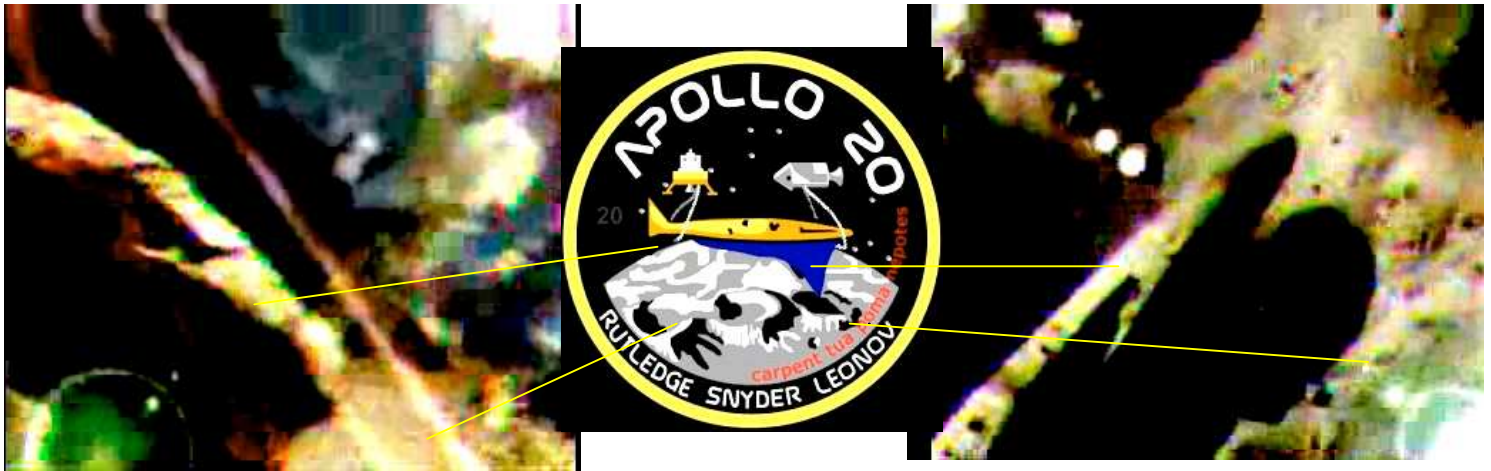

Pictures taken above the Izsak-Delporte area, which should be connected to Apollo-20's emblem.







Mare Crisium

Mare Fecunditatis  
Chang'e 1 crashed on 01/03/2009

August 18, 1976

Delporte-Izsak

Izsak

On **August 18**, late in the evening, the lunar module **Phoenix** landed at Delporte-Izsak D area. Delporte has a diameter of 47 kilometres, Izsak 30 kilometres. Since the area is on the far side of the Moon there is no light and contacts between Phoenix and the ground control were severed. Almost simultaneously **LK Luna-24** took off from Mare Crisium with one cosmonaut onboard.

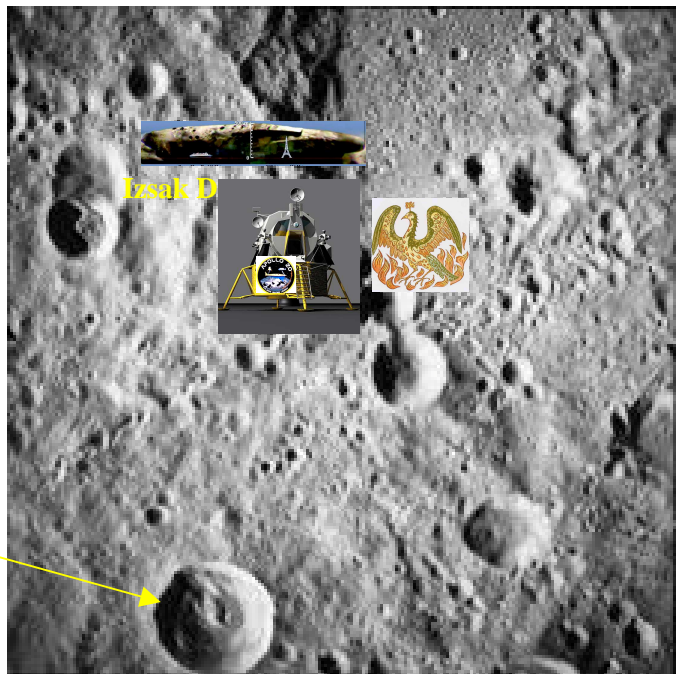
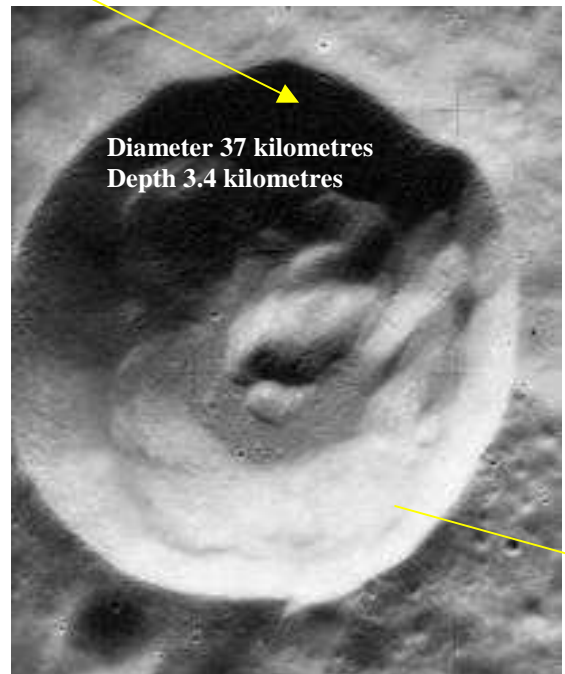
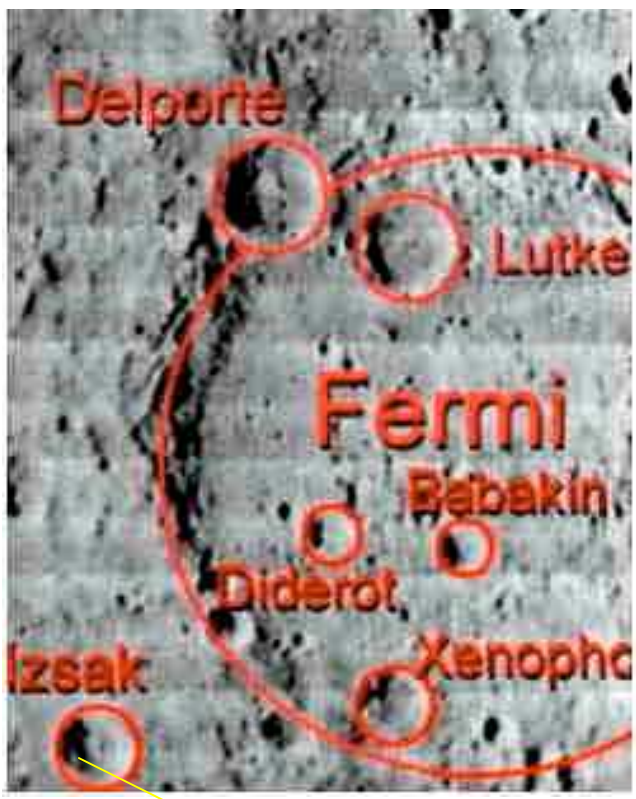





Commander William Rutledge in Phoenix with a camcorder in his hand

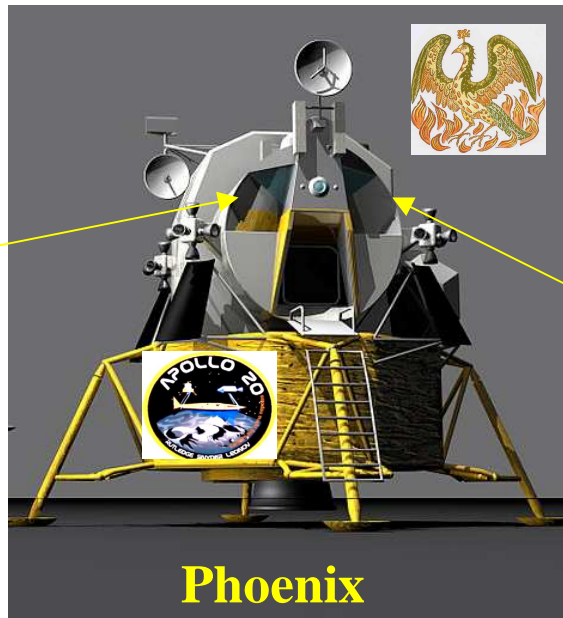

**Phoenix**



Alexey Leonov  
Phoenix pilot



Interior of lunar module **Phoenix**

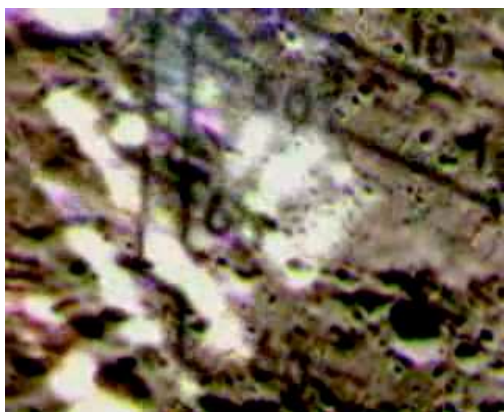

Phoenix descends above the Delporte-Izsak D area



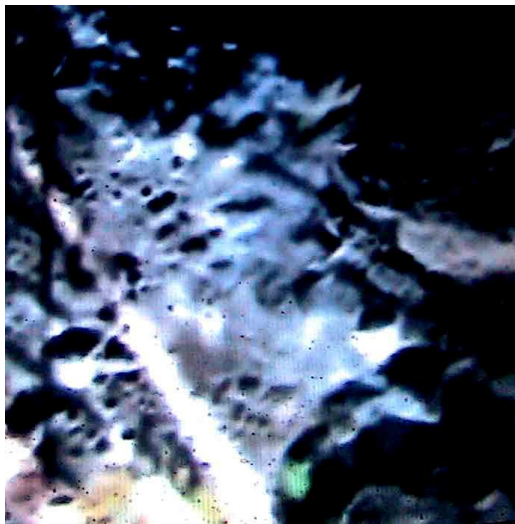

Phoenix descends above the Delporte-Izsak D area

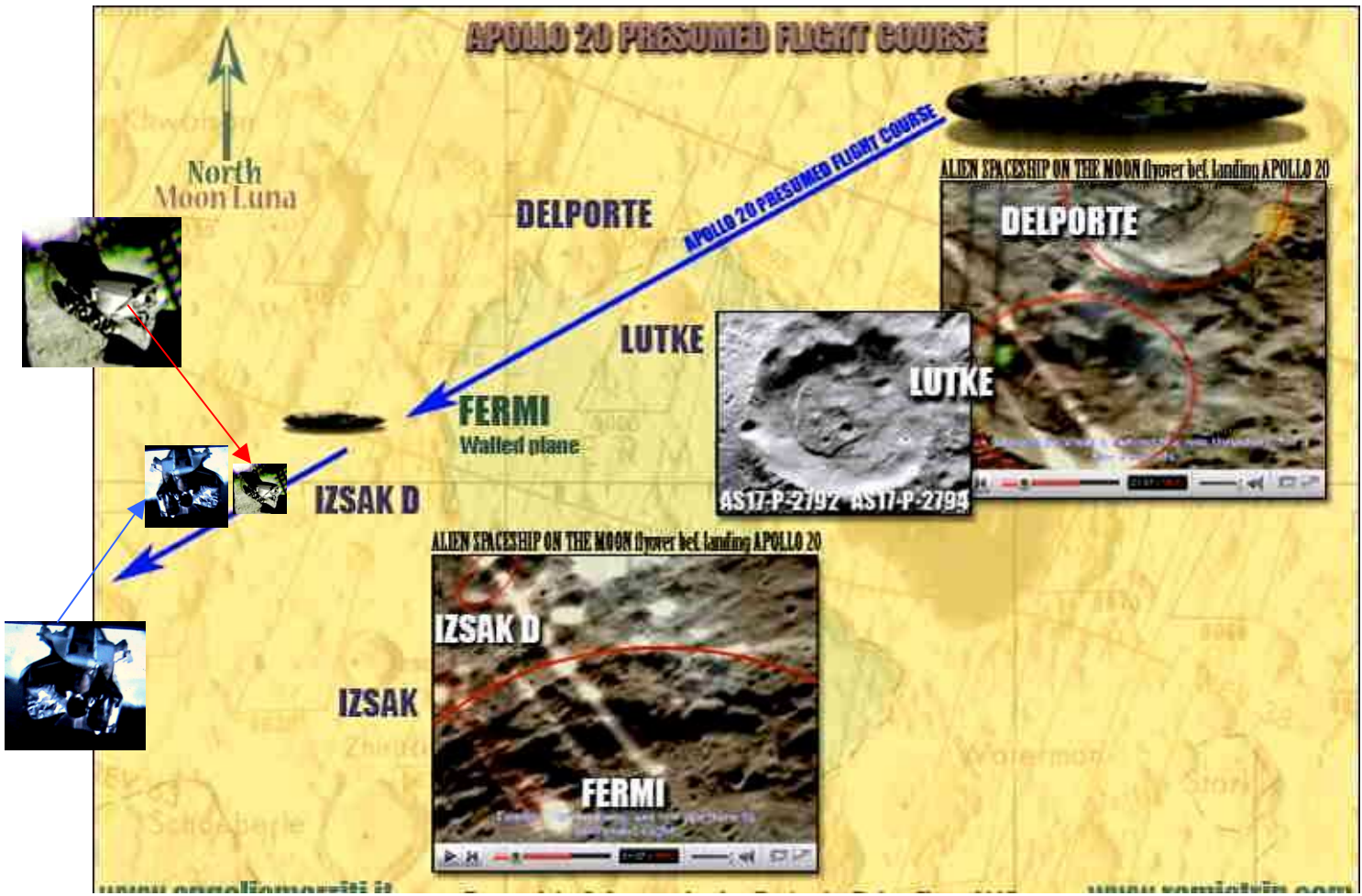
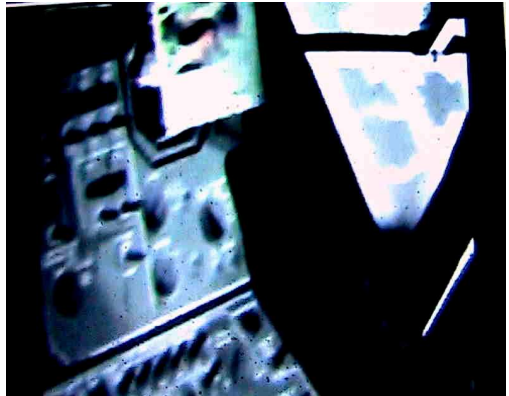

Phoenix descends above the Delporte-Izsak D area



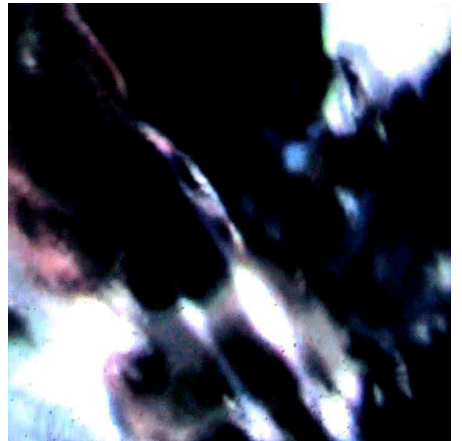
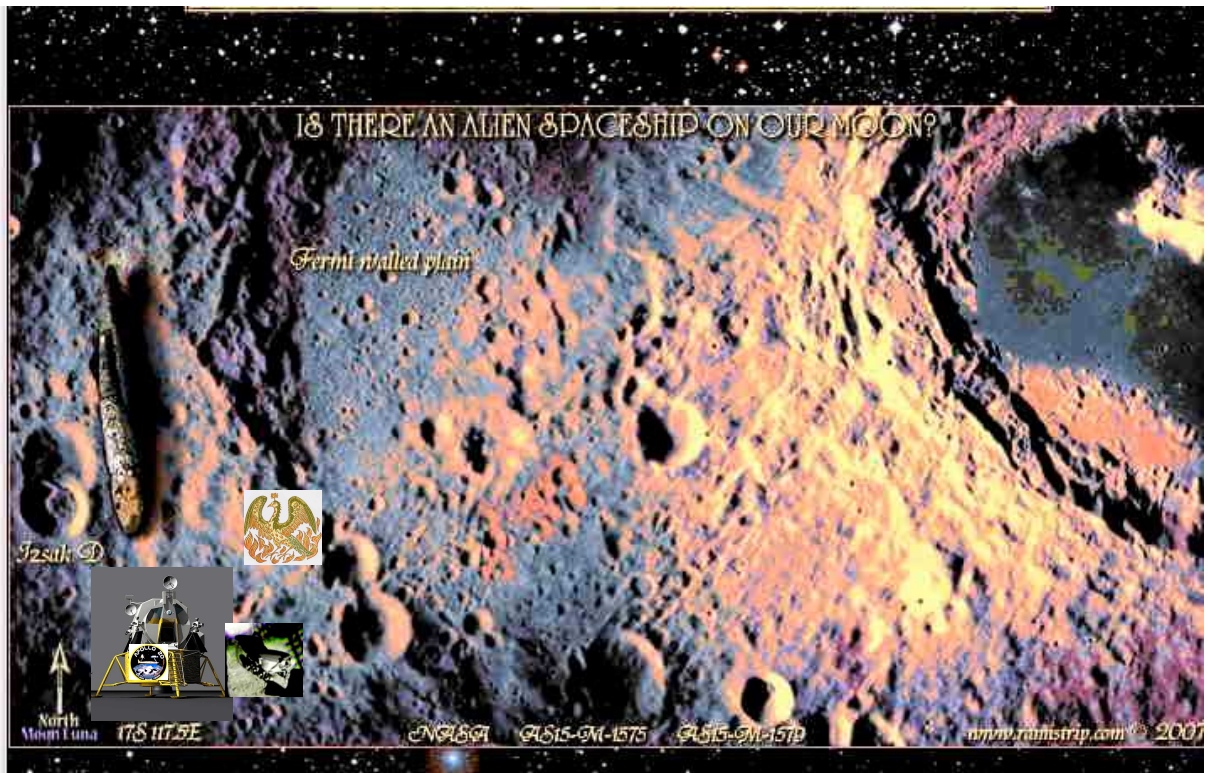

Phoenix descends above the Delporte-Izsak D area and approaches the gigantic spaceship with a length of 4 kilometres and a height of 500 metres.

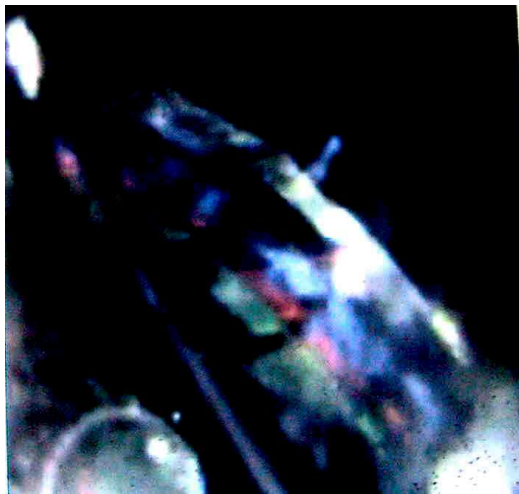
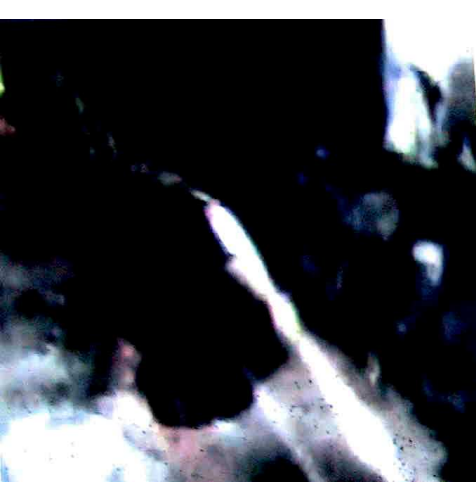

Phoenix descends above the Delporte-Izsak D area and approaches the gigantic spaceship with a length of 4 kilometres and a height of 500 metres.



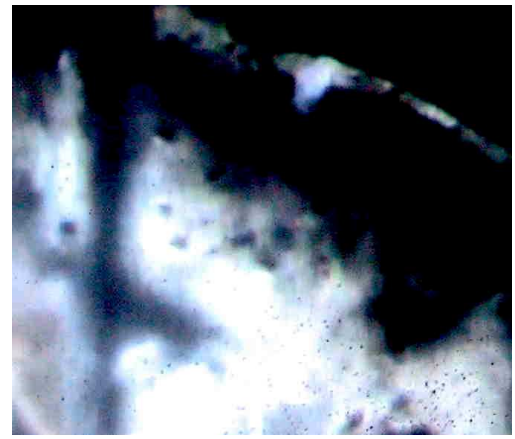
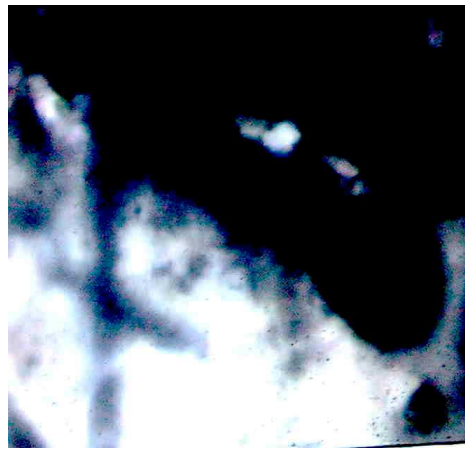

Phoenix descends above the Delporte-Izsak D area and approaches the gigantic spaceship with a length of 4 kilometres and a height of 500 metres. In Phoenix's window we can see that it is watched over by two flying saucers. It has not yet landed, but there is already security.

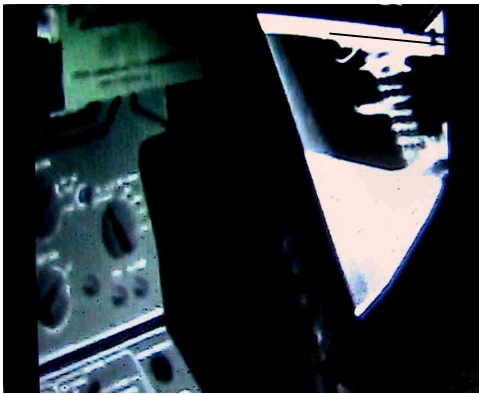

Lunar module Phoenix continues its soft landing with astronauts William Rutledge and Alexey Leonov on board. Suddenly a Soviet lunar roving vehicle turns up in Phoenix's window. It is clearly visible.





The Soviet lunar roving vehicle Lunochod 3 was secretly launched during the summer of 1976 and performed an excellent soft landing close to Phoenix. At the same time we can see a flying saucer passing the lunar module. The lunar roving vehicle above, outside Phoenix, is similar to vehicles of the Lunochod type. Lunochod 3 is today at the NPO Lavochin Museum in Khimki (Russia). It ought to be a copy, since the original vehicle is still on the far side of the Moon, not far from the gigantic spaceship, the target of this mission.

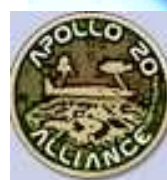
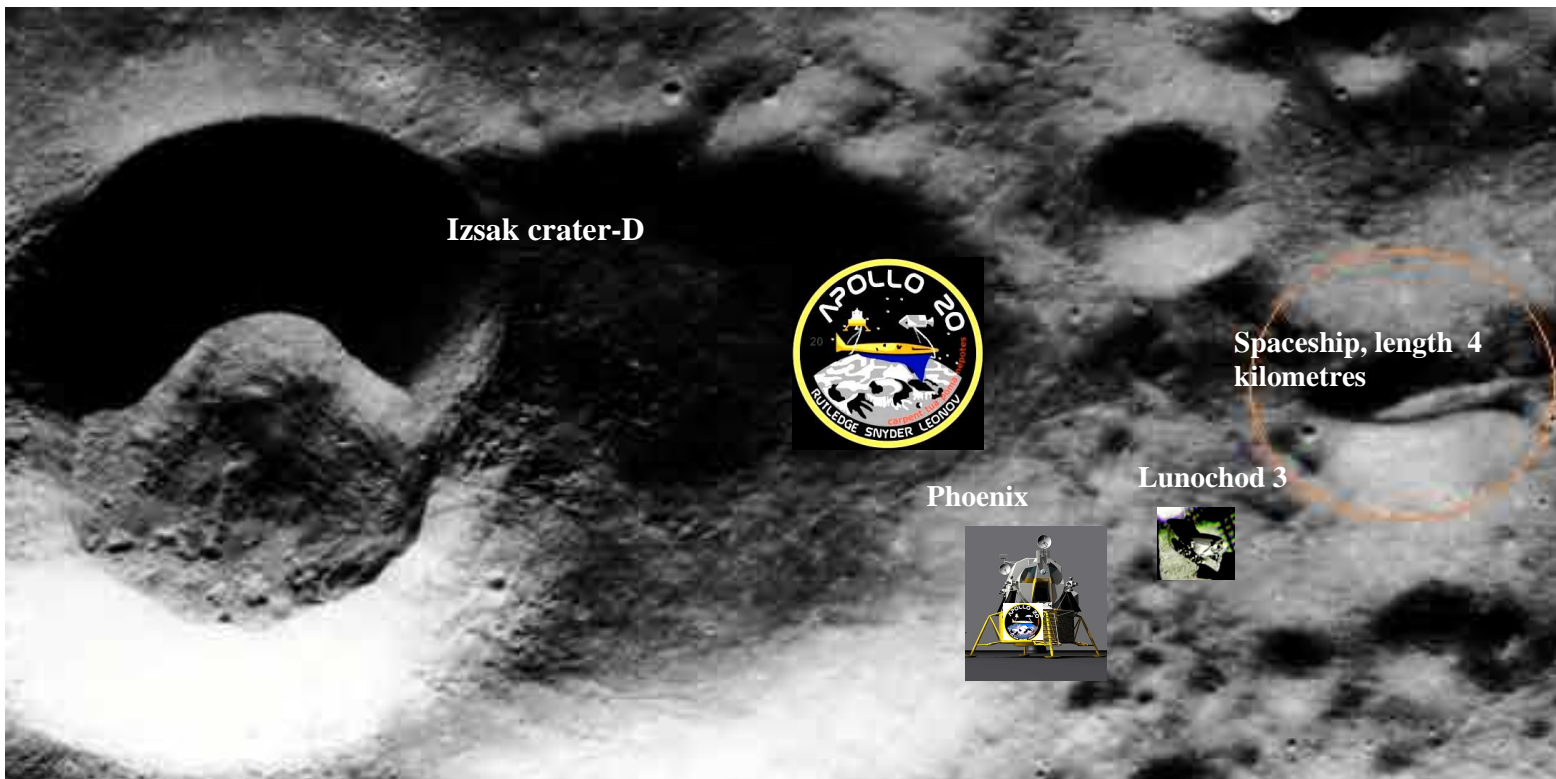

Phoenix with astronauts William Rutledge and Alexey Leonov landed on August 18, late in the evening. As far as I understand, Phoenix landed close to the Soviet lunar roving vehicle Lunochod 3, not far from the gigantic spaceship belonging to the aliens. It is almost obvious that a guide was provided to help the crew of Phoenix.



The guide, to my understanding, was the well-known alien Jarod 1 from Area 51. He had probably already secretly met with the Apollo-20 crew on Earth. We can see from Apollo-20's emblem that there was communication between the spaceship, the Apollo-20 crew and the two ground controls.

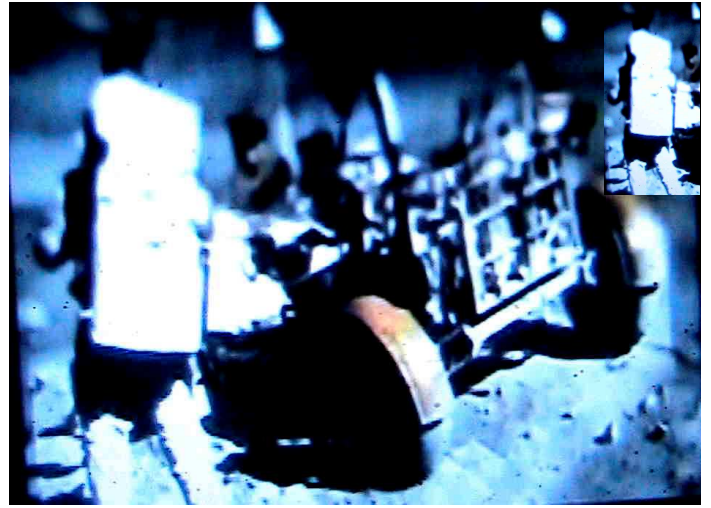
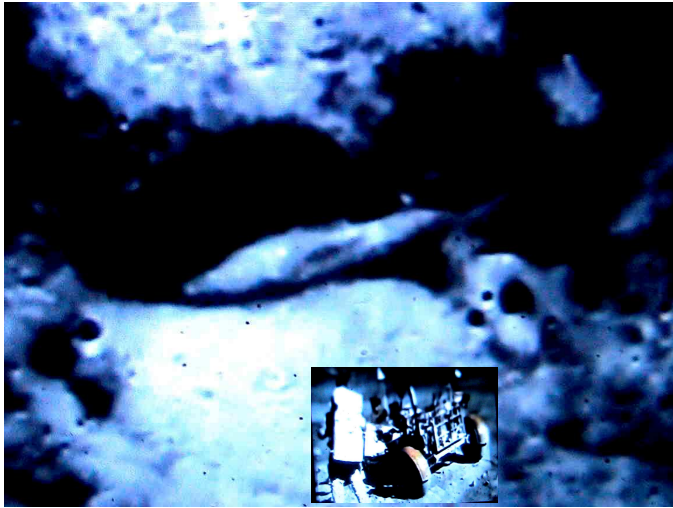

The crew's first assignment was to visit the gigantic spaceship which was not far from Phoenix's landing site outside Izsak crater D. They embarked the lunar roving vehicle and established the direction towards the spaceship, or maybe the guide helped them. Since the far side of the Moon is in darkness, the crew had to use extra light when video-recording and taking photos. The crew were allowed to enter the spaceship, but they were not allowed to record video or take photos inside.

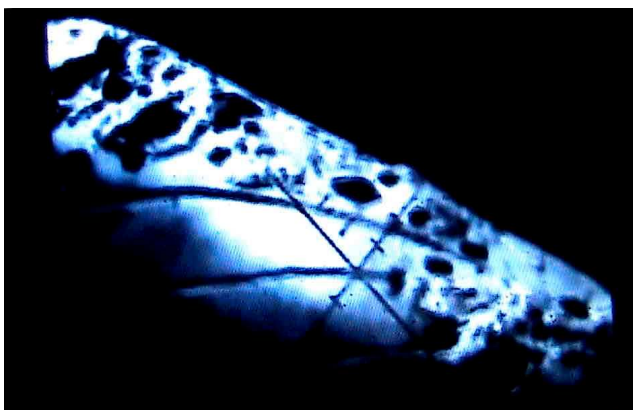
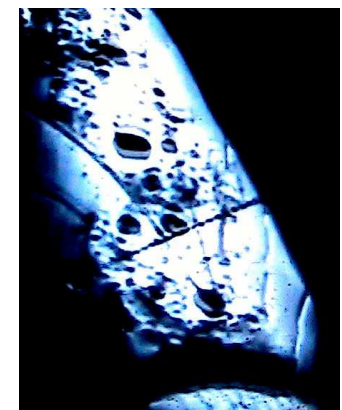
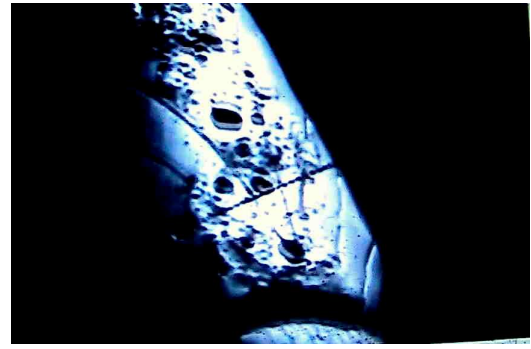
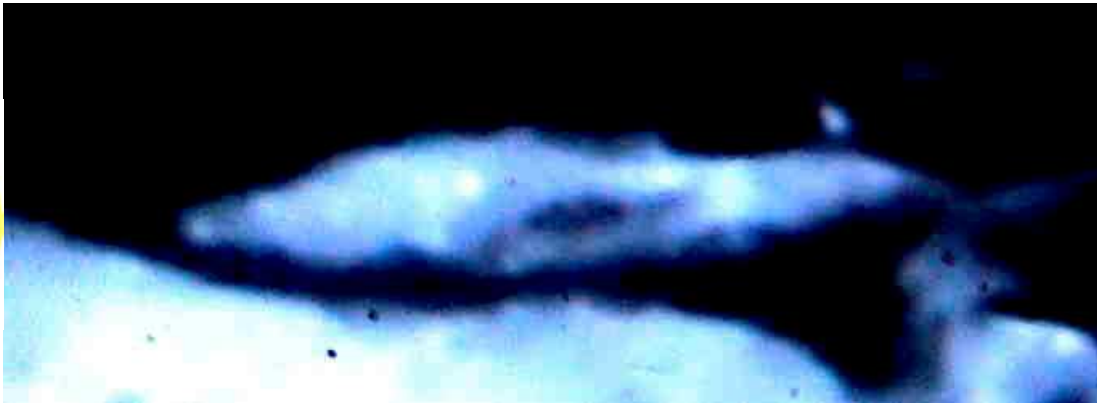

The whole exterior of the spaceship is covered by mysterious signs and symbols.



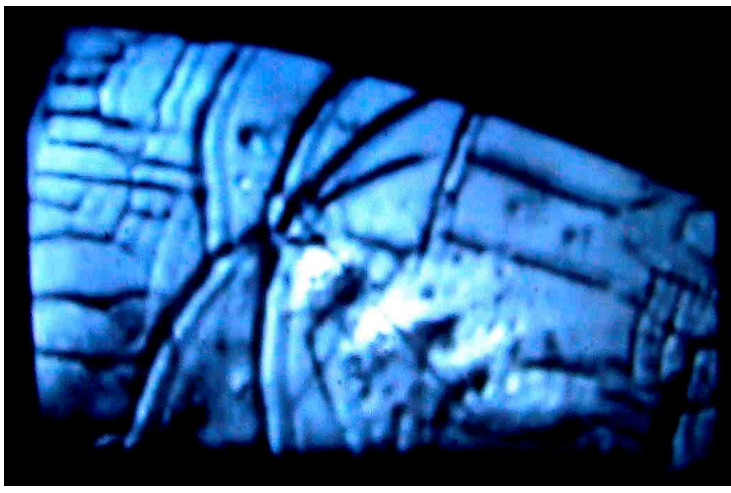

One symbol is a tree with four branches, next to it are three different characters.

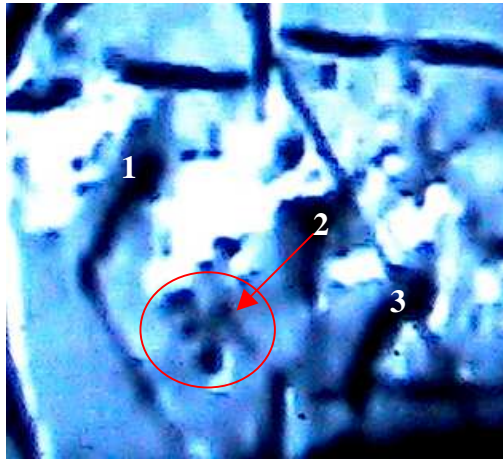

In front of the middle character is a crescent and the letter A. This letter, within Christianity, means, among other things, beginning.



A name is written on the exterior of the spaceship. It has the letter A, a crescent, a J-like letter and a Y. What does this word or name mean? Tree of Life?

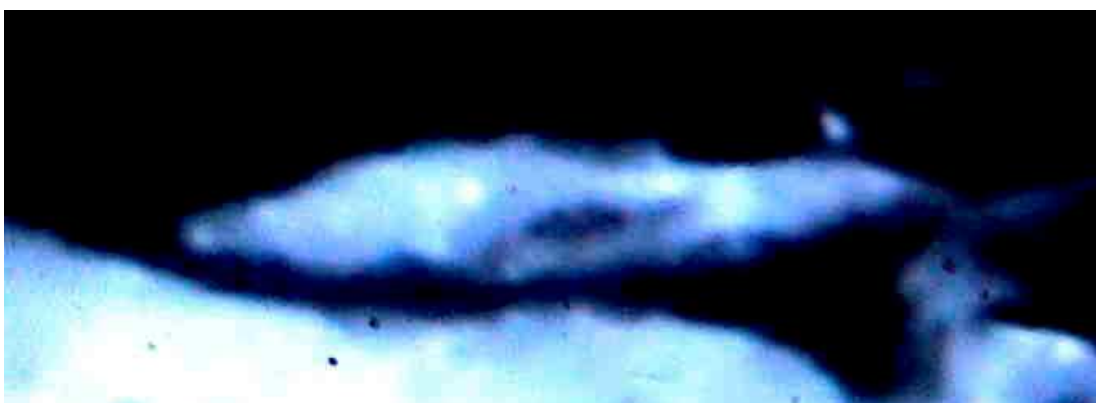

The long, cigar-shaped spaceship is illustrated by lots of different signs and symbols on its exterior. The question is what it looks like inside. The crew does not say anything about this visit or how they were received. They say the spaceship is a ruin.



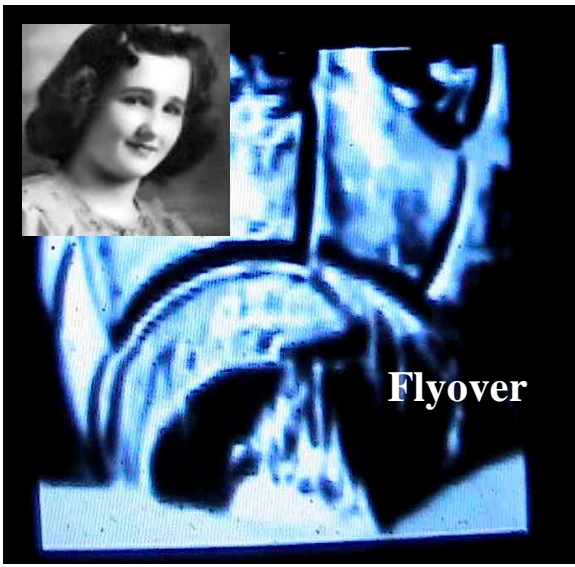

Leona M. Snyder sees the Earth like this from the mother ship Flyover. Flyover is here above the front side of the Moon and can communicate with the ground control. She announces that the Phoenix crew are at the gigantic spaceship.

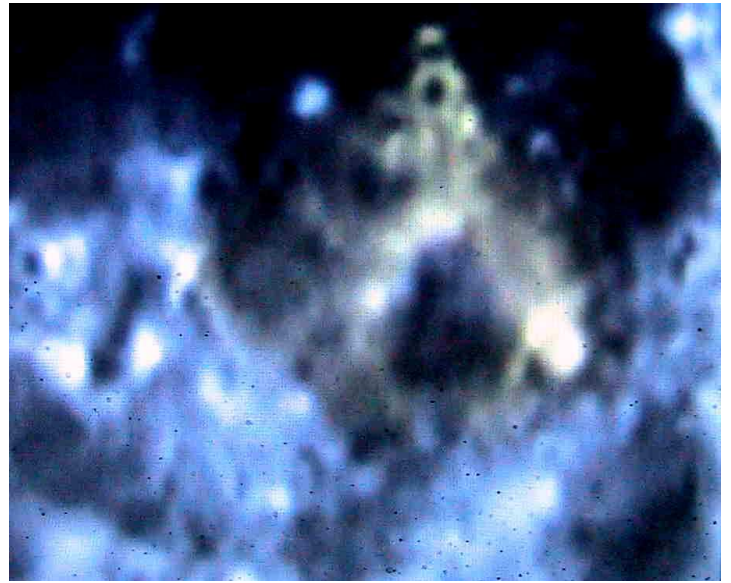

The crew went from the gigantic spaceship to a triangular building, not far from the cigar-shaped spaceship.

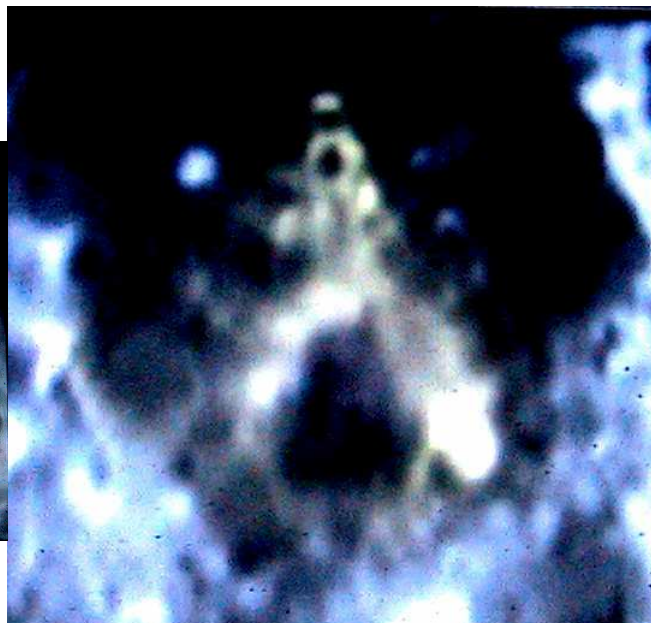

In this triangular building the astronauts found two bodies. Some people suggest that this building is a triangular spaceship, but it can also be seen as a pyramid. Anyway, the crew visited this place, but they do not say much about this site either, apart from it being a ruin. They were not allowed to film inside. It is said that there is one more triangular object.



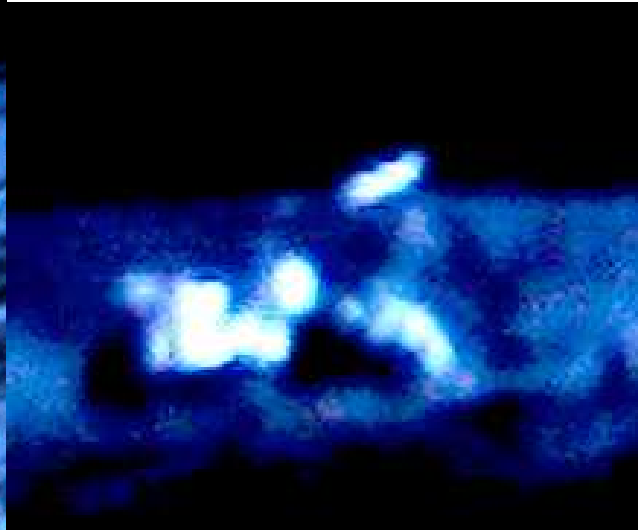

From the triangular spaceship (building/pyramid) to the scientific city, or the so-called "city of knowledge". The lunar roving vehicle with the guide in front.

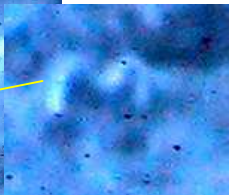
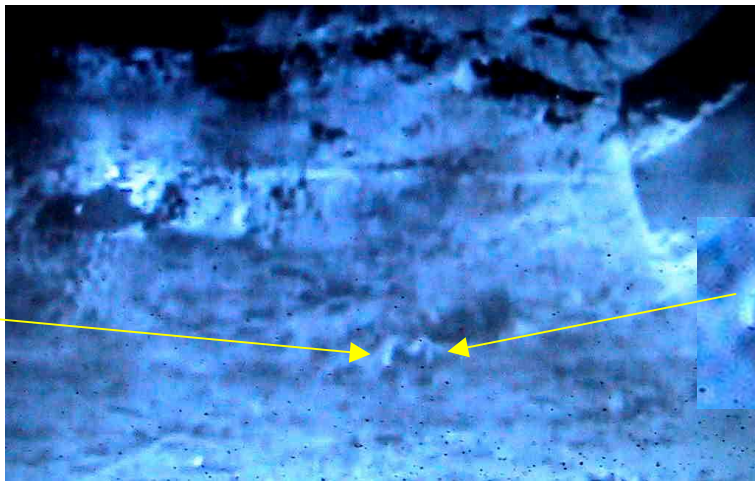

On the road, the illuminated vehicle travels towards a building. On the ground opposite the vehicle is a cross. On the cross we can clearly see the letter **M**.

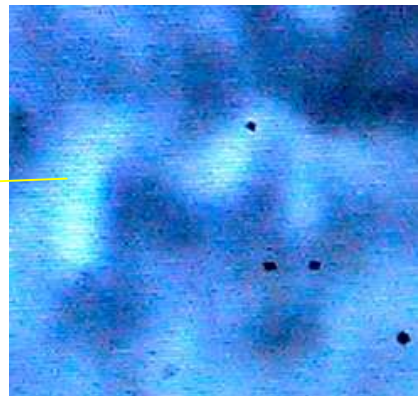
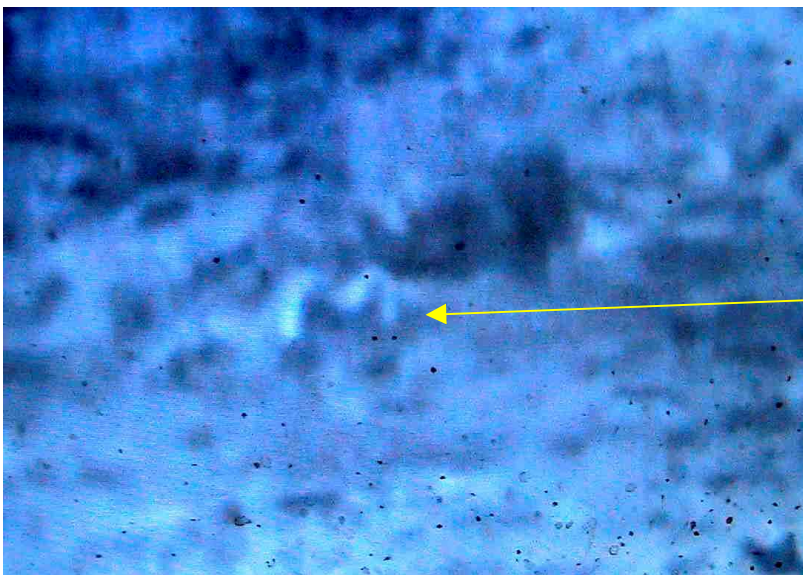

I do not know whether the crew noticed the cross and the letter M during their tour.



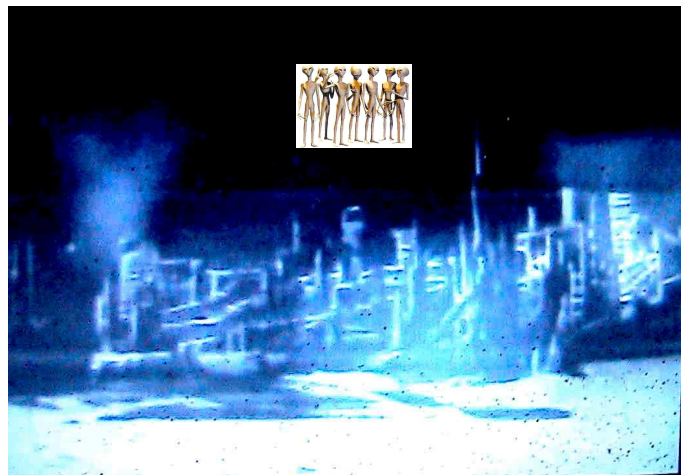
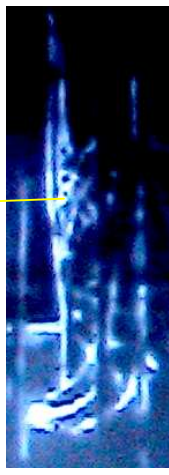
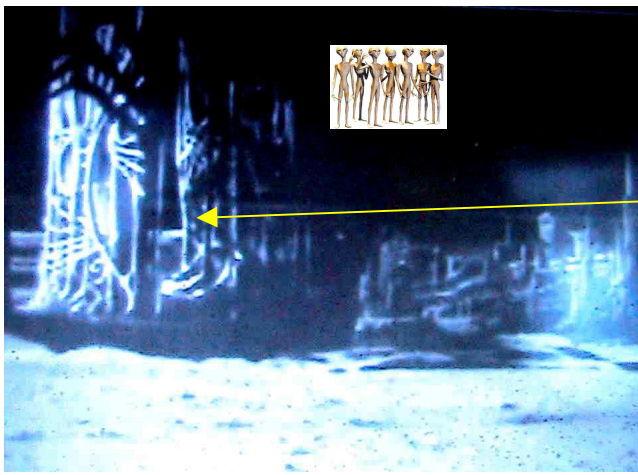

We can clearly see that the entire building is covered in different signs and symbols. We can see a tree next to a crescent-shaped object.

Evening or night

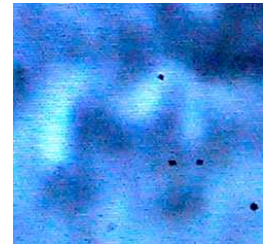
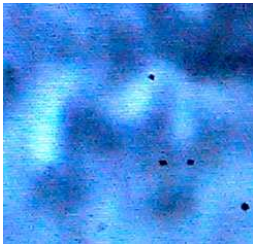

Evening or night

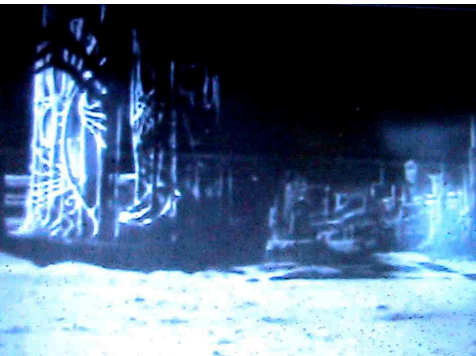

The building is long and has various symbols. The astronauts were probably allowed to film only one side of the building, as seen above. Were they let in and did they visit? They say nothing. They claim that that the building is a ruin even if it does not look like one. I will return to this building later on.



**Message to the Earth**



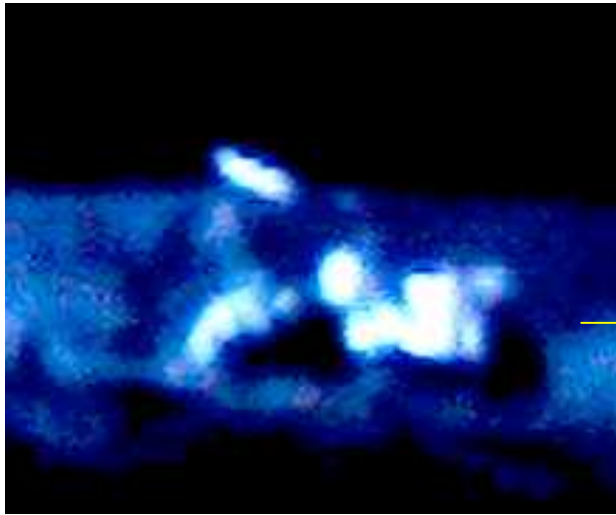

Back to lunar module Phoenix from the building via the city of knowledge, the lunar module outside Izsak crater D.

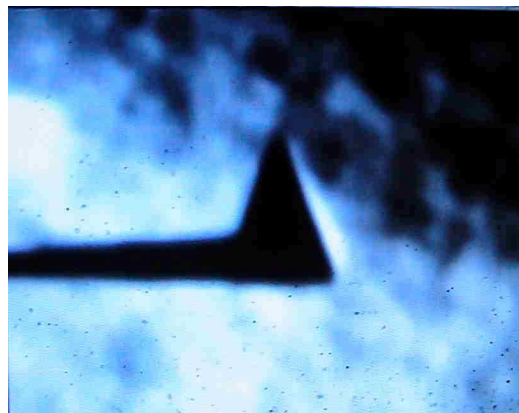
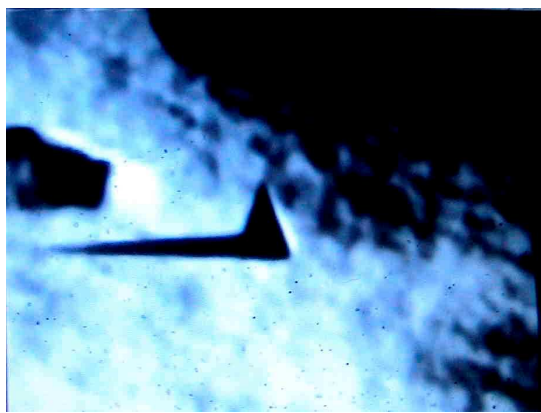

Structures of various buildings.

A building and a pyramid are clearly visible.

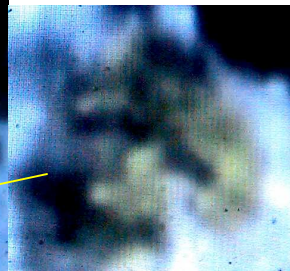
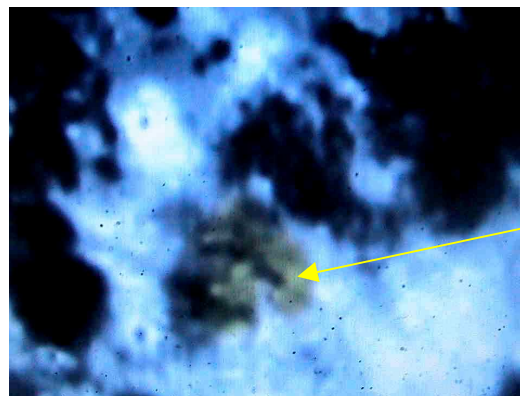

Statue of a queen

A king's head



When astronauts William Rutledge and Alexej Leonov came back o Phoenix, they found two unknown bodies.



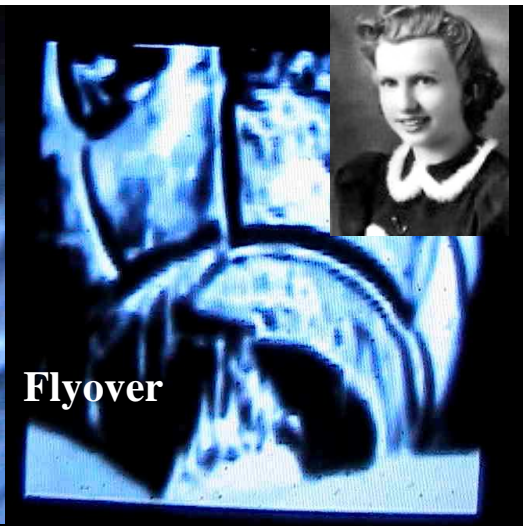

The mother ship Flyover again contacted ground control and she said that William Rutledge and Alexey Leonov had visited a large building, that they had just left it behind and were on their way back to Phoenix. Ground controls in Vandenberg and YEVPATORIYA were briefed about what happened on the far side of the Moon. They could follow the exact activities of the crew outside Izsak crater D and in the city of knowledge. Leona Snyder handled contacts perfectly from Flyover.

?



1

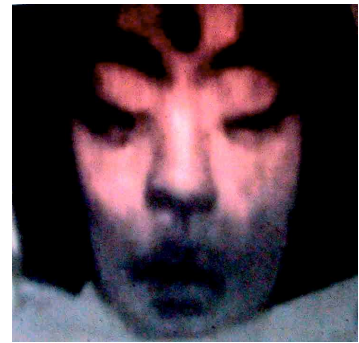

?

2

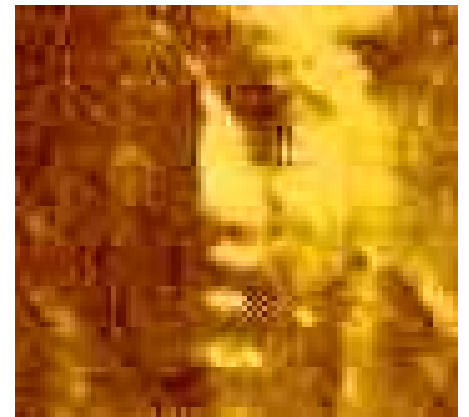



As we follow Apollo-20's program step by step we ask ourselves who these bodies are and why it is so important to visit the triangular spaceship and see these individuals. And why were the bodies transferred to Phoenix? Are these two bodies a message to the Earth?

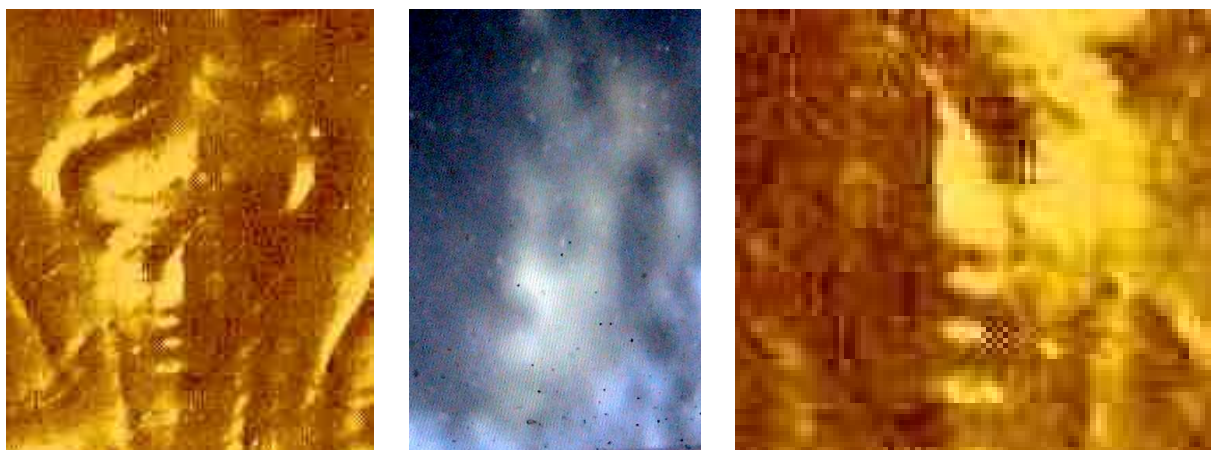

When I saw the short episode about this body on YouTube, my first spontaneous reaction was that the woman looked familiar. Her face is of Sumerian origin and it must be **Inanna** of Sumer. The giant statue of the queen in the city of science is Inanna, the Queen of **Heaven**, her then title. Inanna was not an actual woman, she was a hybrid, a virgin, neither man nor woman, but in those days she played the role of a woman. The animals of her origin were two serpents, one male and one female. More info at *Obscure Magyar*, the first pages.

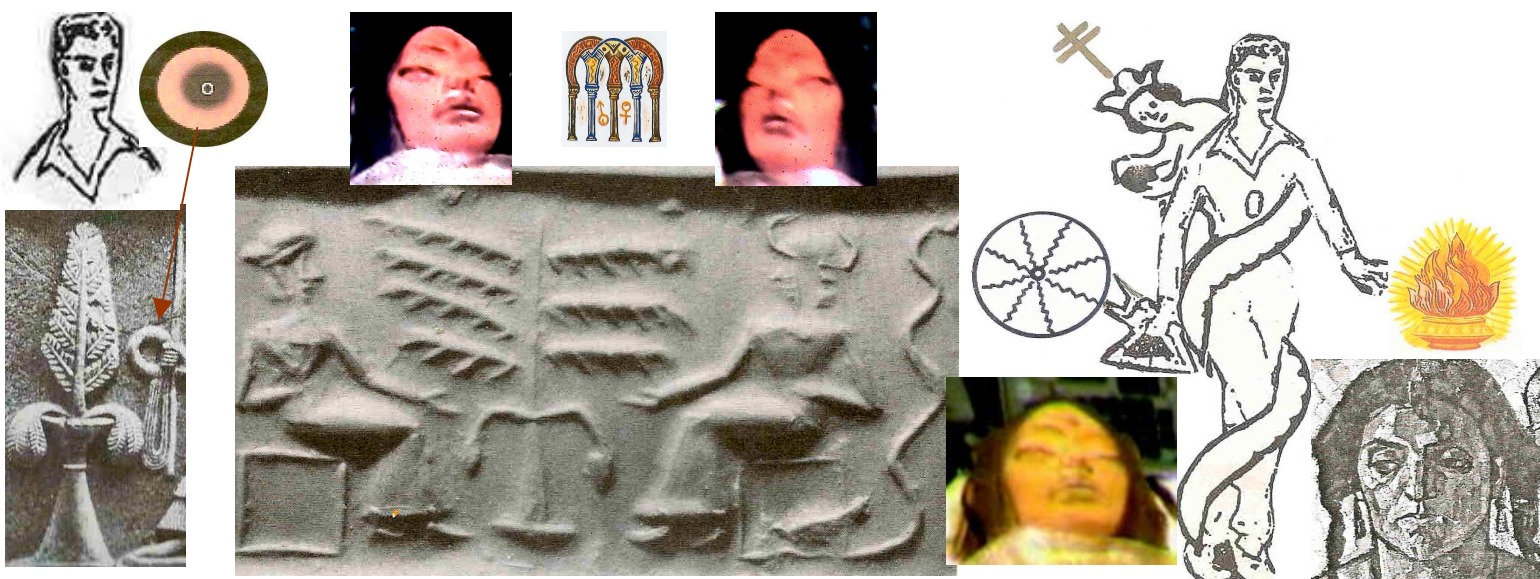

**The jack-of-all-trades Huluppu and his family tree.**

At the centre is the cosmic tree of life, Huluppu's family tree. To the right of the tree is Dumuzi, Inanna's husband, Inanna herself is on the left. Behind her is a serpent wriggling upwards. There is also a wriggling twin-headed serpent on the tree. This message is from her time.

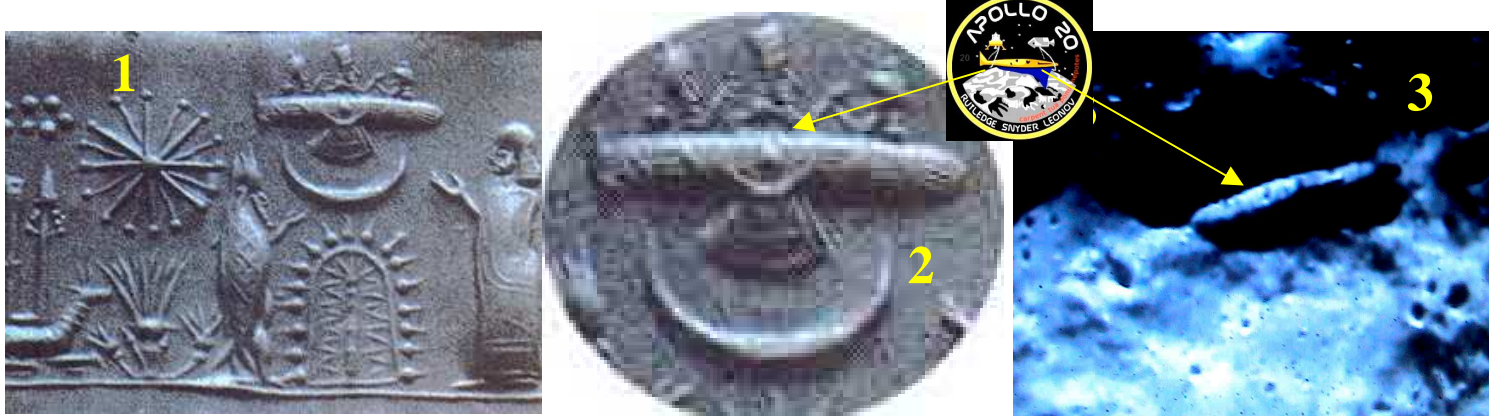

The relief is from Inanna's time. We clearly see, **pict. 1**, that the natural star AN with its seven planets is inside the solar system and that natural catastrophes are for real. A cigar-shaped spaceship is waiting to fly above Inanna and her company and on to the Moon. Below the spaceship is a triangle in the form of a pyramid and below that a crescent. The aliens moved Inanna and her activities to the far side of the Moon **pict. 2**. **Pict. 3** confirms that the same cigar-shaped spaceship is on the far side of the Moon, Apollo 20 paid a visit in 1976. Below the spaceship and the crescent we the cosmic tree of life, **pict. 1**.





Apollo 20's emblem and program.

The cosmic tree of life is visible on the exterior of the cigar-shaped spaceship.

A short summary: the body is Inanna, who was saved from Sumer after natural catastrophes. Her religious centre was transferred from Sumer to the far side of the Moon. There are still activities generated by Inanna and the aliens there. Her goal is still to take over the cosmic tree of life even though she knows it is biologically impossible, an animal can never replace a human being in this context. Now we have shed some light on one body, what remains is to bring light on the second body as well - Izates II/Jesus, a reincarnation of Inanna.

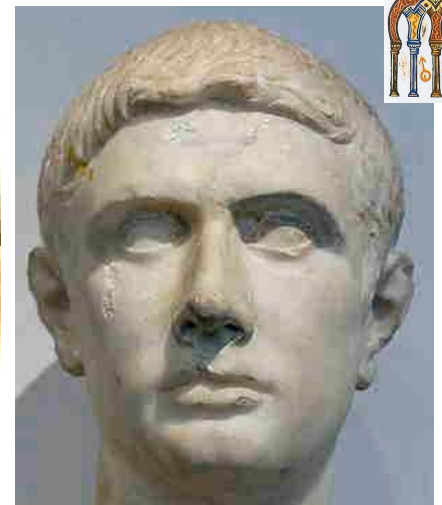
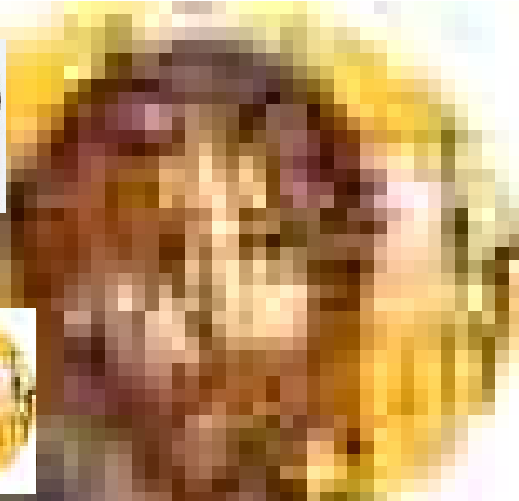

Izates II/Jesus/the Lamb  
Original face

Izates II/Jesus/the Lamb  
Contemporary painting, convent at the Sinai Peninsula

Brutus, son of Julius Caesar  
A reincarnation of Izates II/Jesus



Jakob, Izates II/Jesus  
äldste broder

Izates II/Jesus original face

Black Madonna/Queen Helena  
Painted by Luke the evangelist

Black Madonna/Queen Helena, Caesar's daughter  
Contemporary painting, convent at the Sinai Peninsula

We can clearly see that the face is not Jewish.

The fact that Helena converted to Judaism is one thing, but her family had nothing to do with the Jews. This is quite clear.

There are no pictures of his biological father. It is evident that Jesus looked like Carpenter Joseph, also according to **Matthew 13:55-58**.

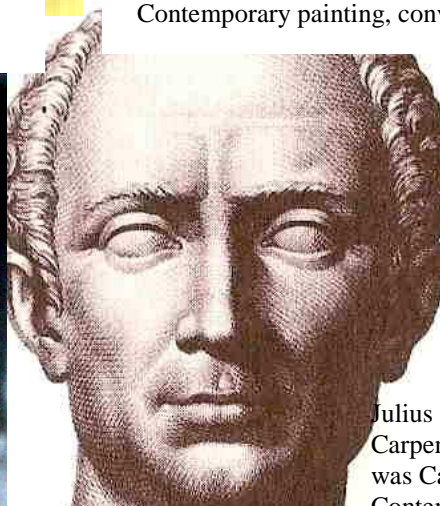
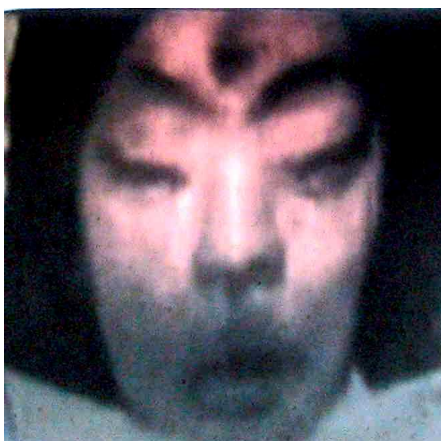

Julius Caesar was related to Carpenter Josef, Izates II/Jesus was Caesar's nephew.  
Contemporary, unknown artist





Saint Stephen, coin from his time, around 1,000 years old, and Izates II/Jesus, the head of his original body, around 2,000 years old. Now we have an original picture of Izates II/Jesus/the Lamb, thanks to Apollo 20's Moon flight mission. According to this picture, Izates II/Jesus was much older than 33 and was not a Jew. The body is well preserved.



In Sumer, during the reign of the divine family, science and knowledge were the most important issues. The goal was to transform animal blood into human, i.e. to become a human being again. Inanna did everything to reach this goal. Here we see a top-modern research institute, connected to the blood transformation process in the city of knowledge. It belongs to Inanna/Izates II/Jesus, the aliens, and is still in use.

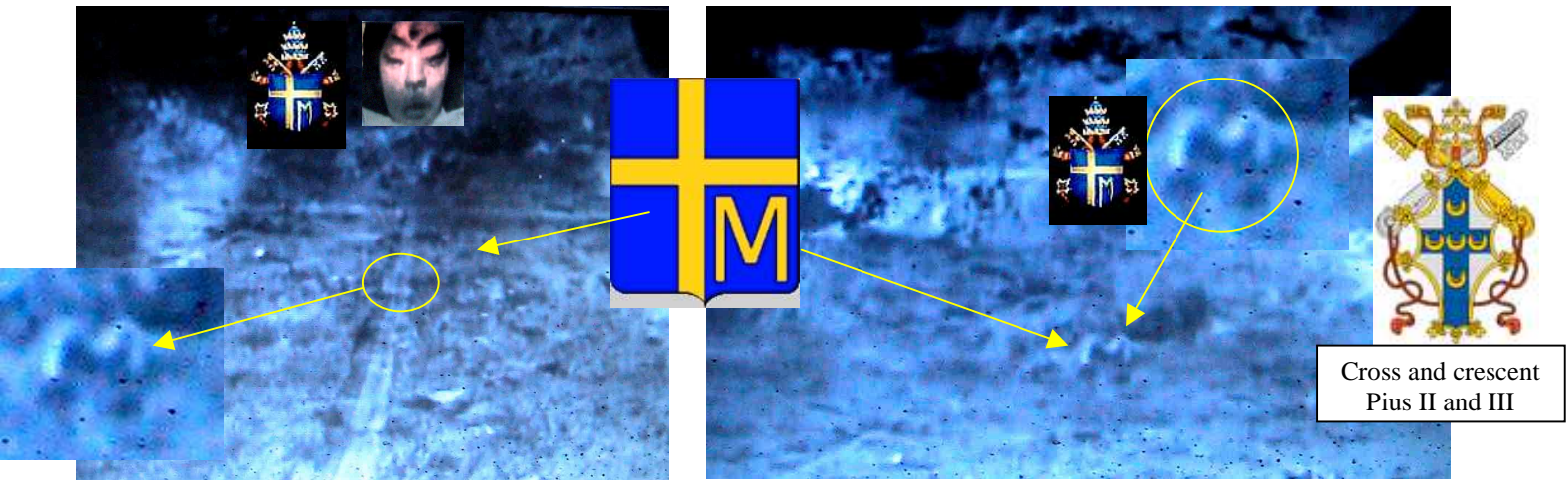

1976. On the way to the research institute there is a cross on the ground; on the cross is the letter M. M = hybrid/virgin. Two popes had an M on their coats of arms, a cross and a crescent. These popes had in common that they were both reincarnations of Moses. M, Tribe of Levi according to the Bible. David and his people had nothing to do with M's activities. We can understand that these aliens were in close contact with the Vatican and the Holy See, where they are called angels. Because of this the Holy See takes the lead when it comes to knowledge of religion, exactly as has been claimed (and still is claimed) by the popes. Thomas's Gnosticism and knowledge are still secretly important.



**John Paul II (1978–2005), Karol Józef Wojtyła**  
266, 110 From a Solar Eclipse

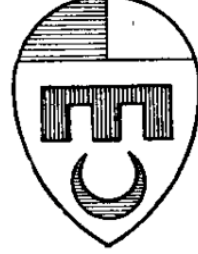

**Eugene III, (1145–1153) Bernardo dei Paganelli**  
69, 3. Out of the Greatness of the Mountain





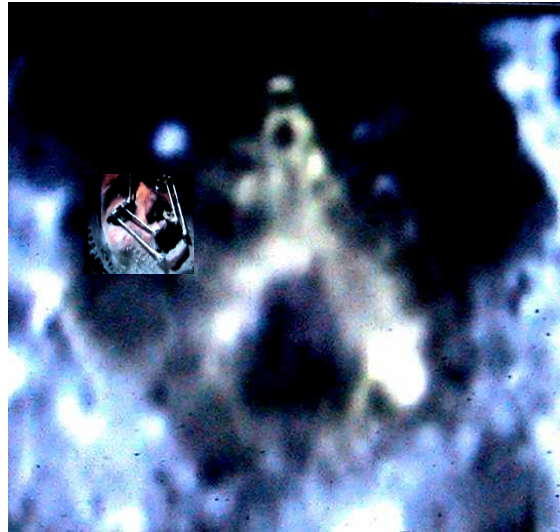
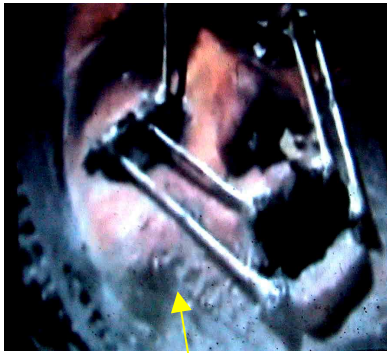

According to this picture, Inanna was the first to be a subject of the blood transformation process in this triangular spaceship. We can see the equipment on her head and there is also a name. Can it be Inanna? At *Dynasty O of Ancient Egypt* I relate how a blood transformation process was carried out, e.g. page 12. She did this before she died and was then reincarnated into a new body. More info at *Mayas-Incas-Aztecs and Their Secrets*, which is also about the blood transformation process in connection with Inanna/the Serpent.

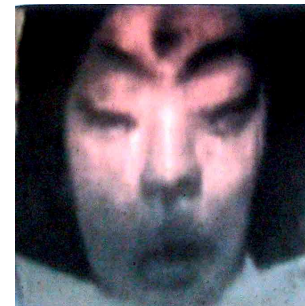

When Izates II/Jesus/the Lamb left the Earth in connection with his ascension in a spaceship (more info at *Akhenaten, the Omnipotent*, page 22), he directly transferred to the far side of the Moon. This is the residence for him and his activities, outside Izsak crater D, in the city of knowledge. He also went through the blood transformation process when he was dying and was thereafter reborn as Nero, more info at *Nero, Fright and Poetry* and *The Fourth Pyramid which Disappeared*, pages 73-74. Each time the Lamb carried out his ascension, he went to his residence the **City of Knowledge**, situated on the far side of the Moon. He did his last ascension but one outside Berlin towards the evening of April 30, 1945. His name then was **Gustav Hitler** and he had been subject to the last blood transformation process. Then he was reincarnated into my family in 1948. I can add, in connection with my father's paternity issue, that the Lamb, Christer R, still has the same blood as that of Inanna's in those days in Sumer.

At *The Fourth Pyramid which Disappeared* I describe how important it was to transform animal blood into human blood, why this failed and the entire research process came to an end. The Serpent had seen to it that everything on the Earth connected to the blood transformation process was destroyed and claimed that the final, correct solution would be reached on the far side of the Moon, in the city of knowledge, but this did not happen. Still, people as well as animals disappear from the Earth. They end up on the far side of the Moon, in the above-mentioned laboratory, as guinea-pigs in connection with blood transformation and research. An animal cannot be called a Son of Man if it is not a human being and of the same blood as a human being. In that way the entire Christian religion fell down in connection with my father's paternity issue, because of the brutal activities by the king, the highest horn, and The Bull.





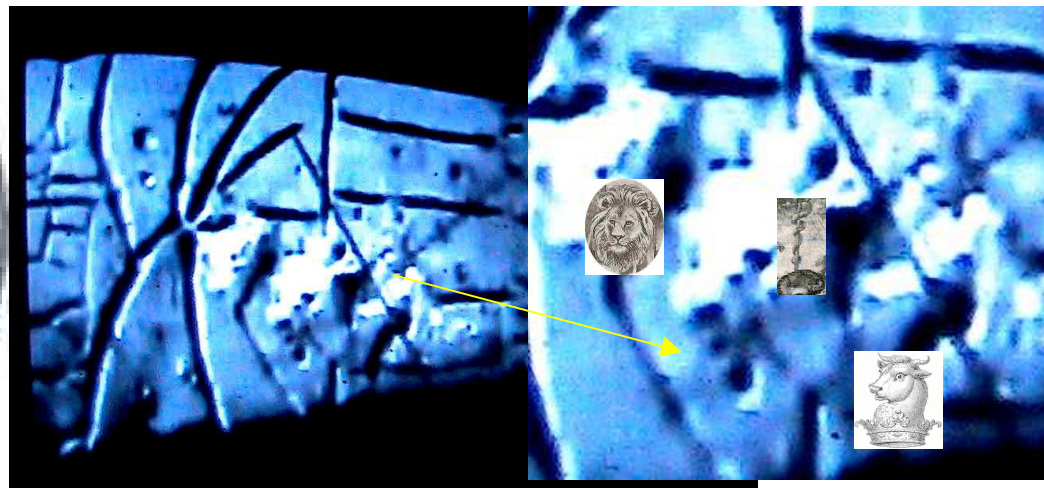

Three characters are clearly visible above the spaceship, illustrating the Lion, Marduk, Serpent Inanna at the centre and the Bull.

On the exterior of the same spaceship, though on the far side of the Moon, the Tree of Cosmic Life is pictured and in front of it are three characters: lion, serpent and bull.

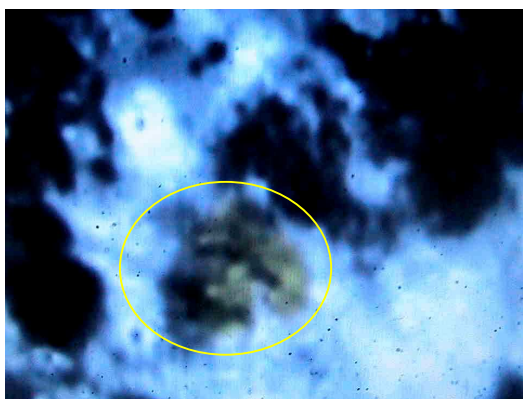

A king's head, should be Marduk/David.

The giant statue of the Queen of Heaven, Inanna.



Identity exchange

Identity exchange



The Lion Tibor E. (1958-1971)

The Lamb Christ R. (1971- around 2007)

The Bull, around 2007-

The time of Huluppu is a reflection of the present day and vice versa, when my father Tibor Kemény was in focus and possessed the paternity role. More info at *Obscure Magyar*, pp 1-7.







# EBE Mona Lisa

The aliens call this woman/Inanna "EBE Mona Lisa". EBE is short for Extraterrestrial Biological Entity, and Mona Lisa is the woman made famous by Leonardo da Vinci. Why Mona Lisa? What is it that the aliens want to tell the world by using the name Mona Lisa?

Now, if the aliens refer to the name Mona Lisa, we should primarily analyse this woman. Many have already done that, but I want to do it my way.

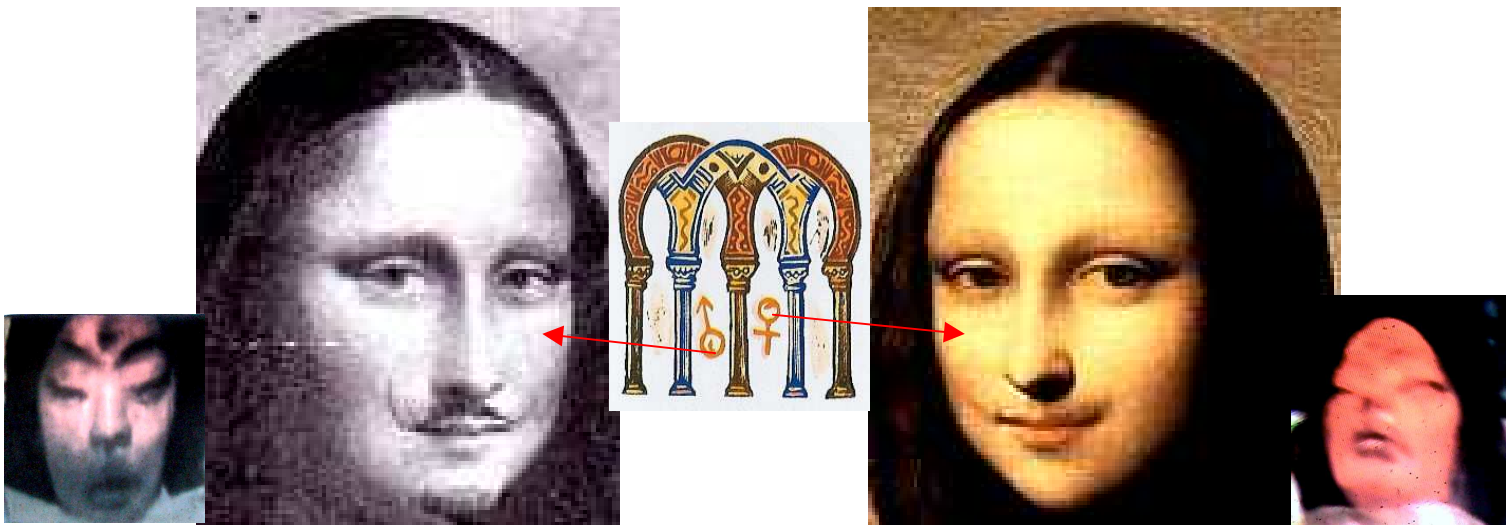

Mona Lisa as a man

Mona Lisa as a woman

When I look at the picture of Mona Lisa, it is difficult for me to see her as a proper woman. Sometimes she looks like a man, sometimes like a woman. According to the pictures she was neither man nor woman, she was a hybrid, a virgin.

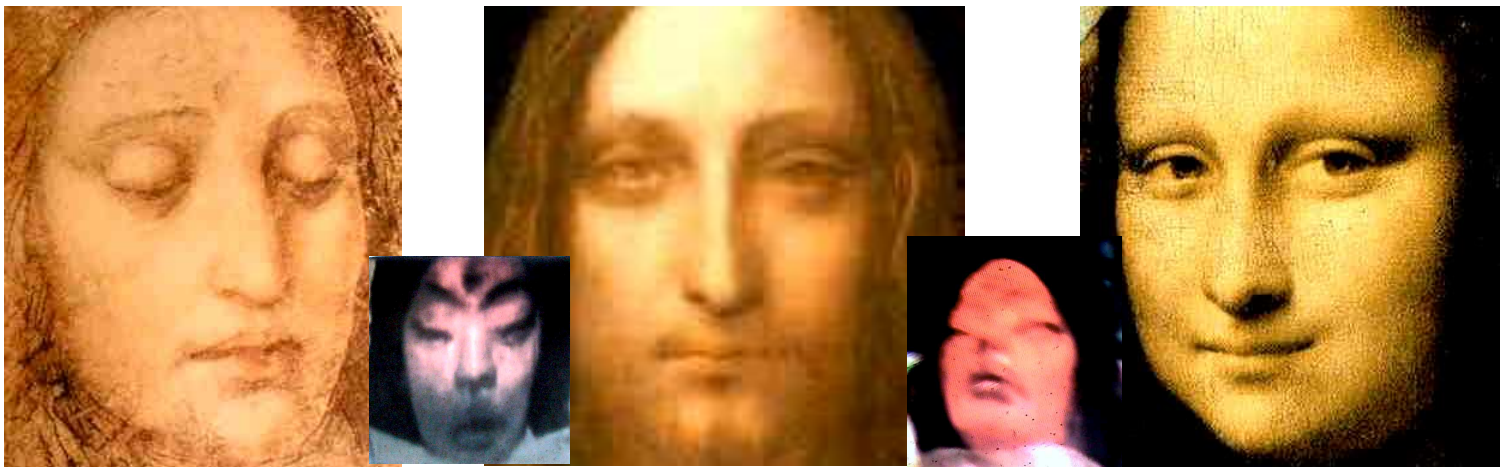

If Mona Lisa was a hybrid/virgin we should study da Vinci's paintings of Christ/the Saviour. He, too, was neither man nor woman, which might mean that the same person sat to da Vinci, since the pictures are similar. In other words: Mona Lisa also sat to da Vinci when he painted the Christ/Saviour portrait.

The question is who this Mona Lisa was and into which family she was born.



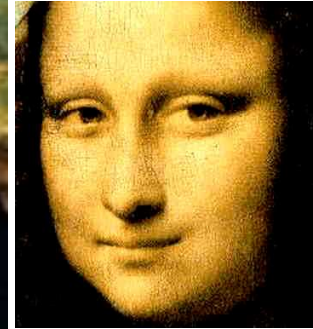

Lisa Gherardini mother and daughter Mona Lisa

Lisa Gherardini was the wife of the wealthy Florentine merchant Francesco del Giocondo. This Lisa Gherardini had an illegitimate daughter and Giocondo himself was at first married to Lisa Gherardini's mother's sister who suddenly died. The question remains: Who was her father, a Medici? As far as I can understand, Mona Lisa was the daughter of Lisa Gherardini, and fosterling of Francesco del Giocondo in his marriage to Lisa Gherardini.

In that way Mona Lisa made contacts with *Giuliano de' Medici* and his family. Thus Mona Lisa was a reincarnation of, among others, Inanna, Izates II/Jesus.

Leonardo received the Mona Lisa commission in 1503 from Francesco del Giocondo. Giocondo regarded himself as a patron of the arts and wanted a portrait for his dining room – that is why the painting is so small. Here, Mona Lisa's story began. She seemed invisible, could only be met in certain well-known wealthy circles. She always dressed in simple clothes, her main interests were science and knowledge, not jewels, parties and life in luxury.

After innumerable interruptions due to Leonardo's laziness (according to his own diaries) and (according to those around him) his bad tempers, the portrait was finished in 1507. During that time the client became impatient and refused to pay for the portrait. So, when Leonardo in 1516 accepted an invitation from King Francis I and moved to Clos Lucé next to the Amboise Castle in France, he brought the painting along. The fact that he took that painting – and few others – suggests that it meant much to him. Later on the French king bought the work of art for 12,000 francs.

Leonardo da Vinci knew exactly who Mona Lisa was, he knew all her secrets, he knew her personally. That is why the portrait took so long to accomplish, focus was on her smile.

The king of France, Francis I, knew exactly who Mona Lisa was, now he got to see her and own her portrait. Francis I was the French king who, between 1521 and 1544, wanted to destroy the Holy See. At first the portrait hung at the Fontainebleau castle, thereafter at Versailles. After the French revolution it was moved to the Louvre. Napoleon I had the portrait moved to his private bedroom in the Tuileries Palace. It was later on moved back to the Louvre. During the French-Prussian war (1870–71) it was hidden somewhere in France. More info at *The Prince of Ponte Corvo* page 25.

It was probably Mona Lisa who acted in secrecy behind the Holy See and it was her idea to have the Council of Trent between 1545 and 1563. The Council of Trent was brought to a close on December 12, 1563, by Pope Pius IV. His diagnose was euthanasia to the church at the end of time. It was Mona Lisa who commissioned the pope Pius IV to procure a painting of the conclusion of the Council of Trent. Pius IV sent the commission on to the artist Pasquale Cati who finished the painting in 1588. Neither Mona Lisa Pius IV saw the great painting. More info at *Capricorn, Aries and the End of Time*, pp 28-32. I can add that Mona Lisa was reincarnated as Queen Christina in Stockholm in 1626.

Louven  
-  
Washington  
1963



Christina's silver throne,



Christina's moon throne



Louven  
-  
Washington  
1963



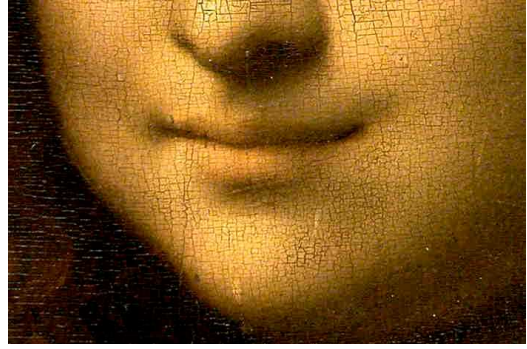
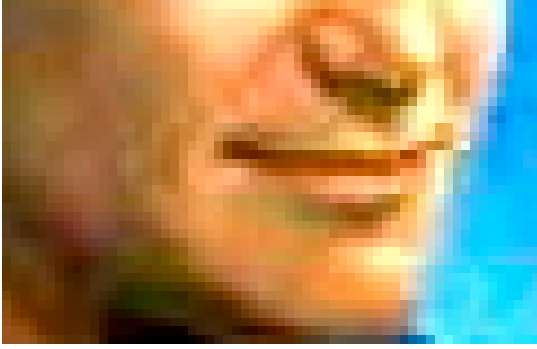
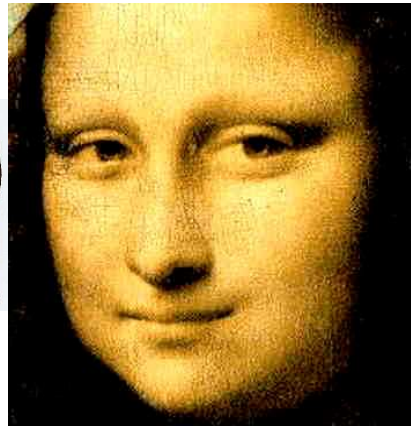

Christer R

Mona Lisa

EBE Mona Lisa

Inanna's legendary smile of a serpent  
Admired by the entire world



I understand that behind EBE, Extraterrestrial Biological Entity, there is a hidden agenda concerning the blood transformation.



# Apollo-20

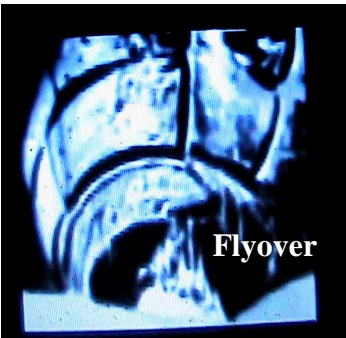

The mother ship is called "Flyover".

**Flyover** means crossroads at all levels. In other words: Apollo-20's moon mission crossed what we know about history, religion and science and highlighted reality

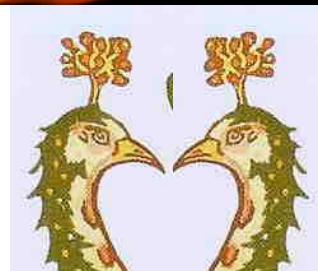

The lunar module was called "Phoenix" and landed outside the city of knowledge on the far side of the Moon. What is the significance of the bird Phoenix in this context?



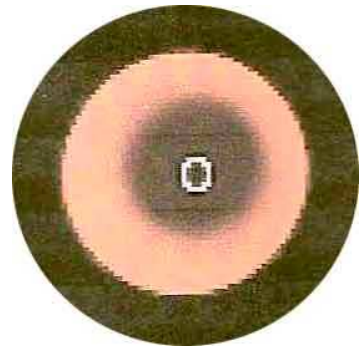

Cosmic Adam/Huluppus was an Aries and Aries, like Lion and Sagittarius are signs of the fire. Here we have the origin of fire as a symbol.

More info at *Aries, Capricorn and the End of Time* and *Obscure Magyar*.

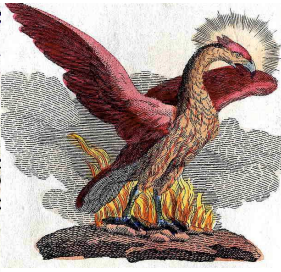
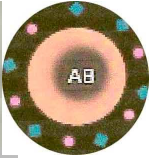
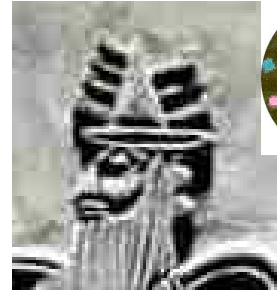

Enki, the scorpion man, Adam of the Earth. The seven-pointed star is his symbol, and the symbol of tribes of his nation. He chose the eagle to be his and his nation's symbol. The eagle named "Turul" is the ancient symbol of Hungary. Enki was the only one to have ever been born into Cosmic Adam's family tree. At the beginning his symbol was called the **Golden Eagle** and the nation he created was called "Aries the Nation." Each time he founded his nation he created top-level culture and science, which made other nations jealous. The latest nation he founded was "Árpád" in Hungary, The eagle Turul was gradually transformed into the bird Phoenix in a symbolic way. Other nations founded by Enki, Adam of the Earth are, for example Scythia by the Black and Caspian Sea (as Menroth the Great), ancient Persia (as Cyros the Great), the Roman Empire (as Julius Caesar), Hungary (as Árpád) and the Aztec Empire (as Tenoch). Phoenix can be connected to all these nations. They were all at the beginning flourishing realms in which knowledge, science, nature and Man were in focus. All these nations disappeared, they all symbolically burnt down and what happened to them? Here we can also include ancient Egypt. dynasties 0 to 4. More info at *Obscure Magyar* and *Ancient Persia and its secret*, page 9.

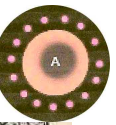
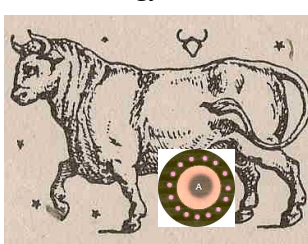

The Bull Gilgamesh also chose the eagle as his symbol to be able to compete with, among others, Enki, Marduk and Inanna, sometimes even using violence. Even Inanna wanted to get rid of Enki and Marduk and their nation. The latest time this happened was in AD 1000 when the Mother Church the Dragon initiated a bloody coup against the pagan Prince Géza. Phoenix appears in history as well as in religion.



Phoenix in a commercial context



Phoenix in a commercial context







# FRANCIS CARDINAL GEORGE, OMI ARCHBISHOP OF CHICAGO

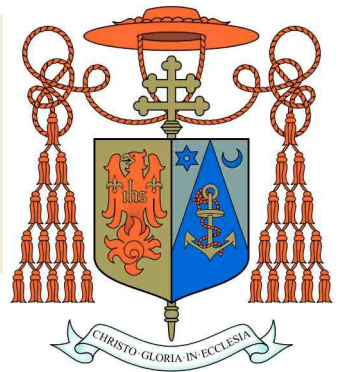
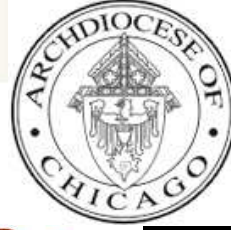

Cardinal Francis George  
Chicago



Cardinal Francis George  
Chicago  
Labarum, for Antichrist

Phoenix at the highest level of religion. Cardinal Francis George and his cardinal coat of arms. If we analyse his coat of arms we notice strange plans in his program.

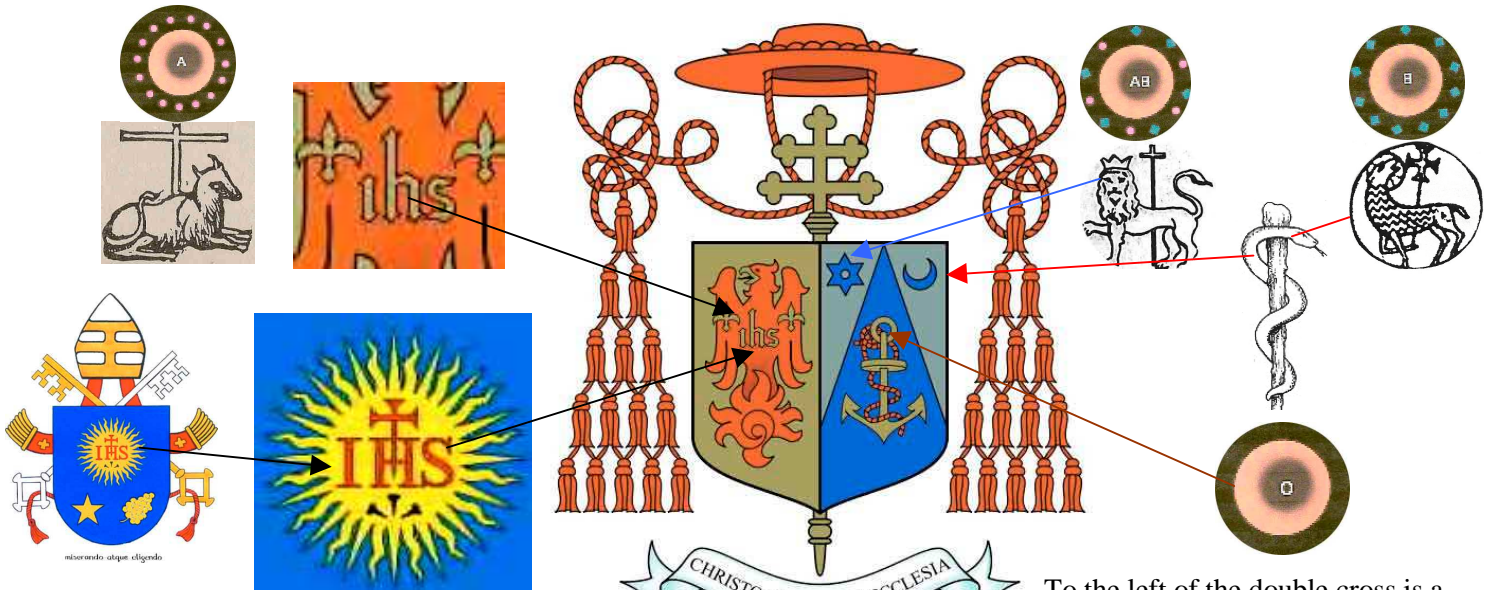

To the right of the double cross we see a Phoenix together with the Order of the Society of Jesus, a Labarum which refers to Antichrist. Phoenix is a symbol of resurrection, everything that perishes will symbolically be resurrected, i.e. Antichrist wants to go on with Christianity henceforth. Here, Phoenix is the Bull God/Antichrist.

To the left of the double cross is a symbol of the end of Christianity.



**Mammon**





# Madison Tridentine Mass Society

## Diocese of Madison

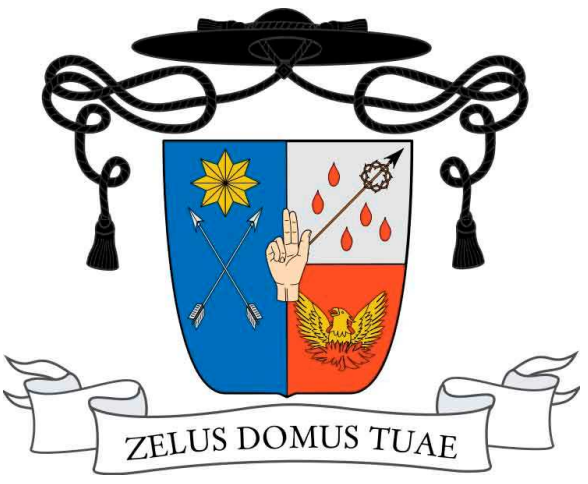

John Zuhlsdorf, new President of the Tridentine Mass Society of Madison  
 The Tridentine Mass Society of Madison was founded in 2007,  
 Part of the Catholic Church

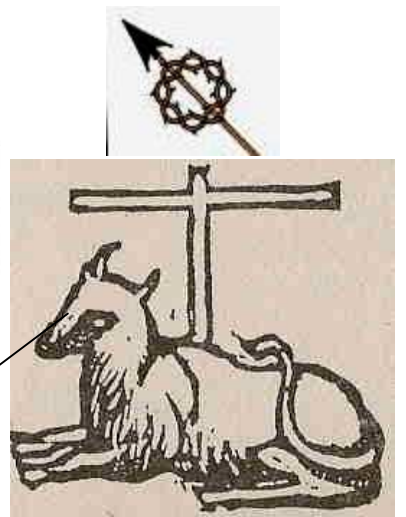

On the blue background is a yellow eight-pointed star. Below the star are two arrows intersecting the star, i.e. the star is to be annihilated.

John Zuhlsdorf's personal coat of arms is expressive. A human hand grows from Phoenix and fires an arrow which kills the eight-pointed star.

The message of the priest's personal coat of arms is fairly clear: the Bull/Antichrist calls himself **Son of Man**. The Son of Man does not kill and a bull is an animal, not a Son of Man. You cannot turn back your clock to the 1970's. More info at **Foundation Stone**, page 70.

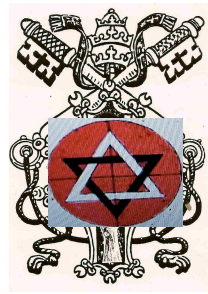

**Antipopes in the USA**  
 Who lived and live in simplicity. Compare them to other popes and antipopes.

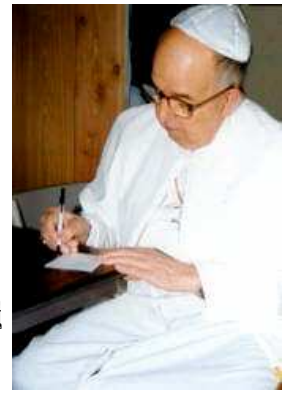
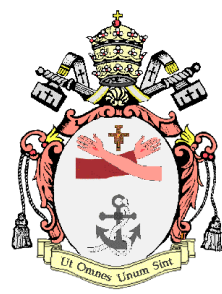

**Michael I, antipope 42 (1990-),**  
**Kansas, USA, David Allen Bawden, in simplicity with nature**

**Pius XIII, antipope 43 (1998-2009),**  
**Springdale, Washington, USA, Lucian Pulvermacher**





# Diocese of Madison

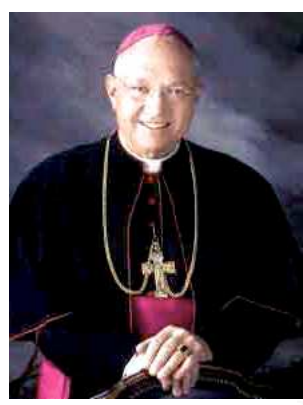

Robert Charles Morlino  
Bishop of Madison

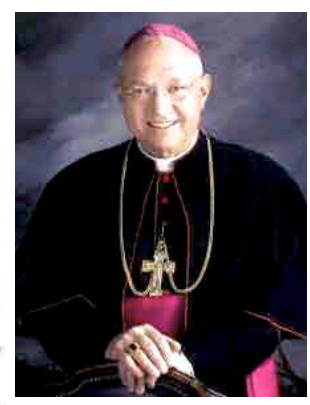

Robert Charles Morlino  
Bishop of Madison

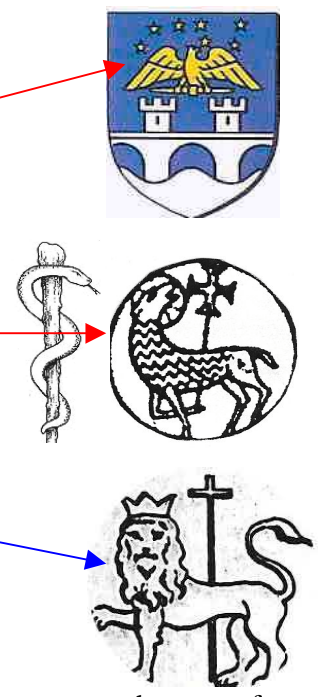
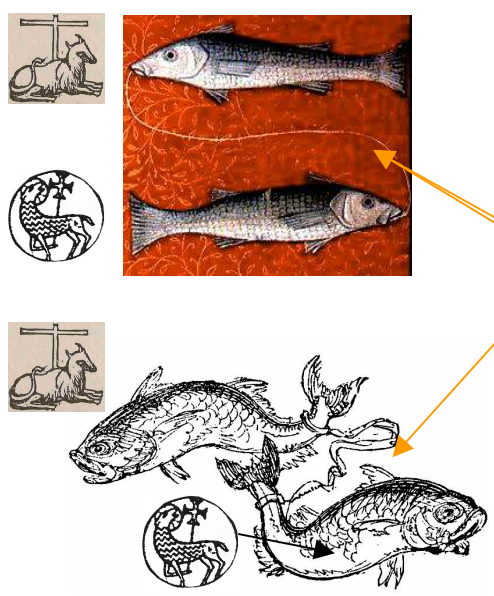

Bishop Morlino's personal coat of arms has well-known symbols. To the right of the cross we see the coat of arms of the Madison diocese which is connected to the zodiac sign of Pisces, where the fish swim towards their own goal in their own direction. Two symbolic Jesuses, each swimming towards his own goal in Christianity.



Phoenix  
and  
religion







# Dead Theologians Society

## A Part of the Catholic Church



The Bull God/God of Death/Osiris



The Bull Jesus Christ



**Dead Theologians Society**, was founded in 1997 in the USA

Dead Theologians Society was founded in 1997 in **St. Francis de Sales Church** in Newark, Ohio, USA, with roots in the Society of Jesus. Among other things it is a secondary school for teenagers who are supposed to be inspired by dead saints while living with Jesus. Its motto is "Dead to the World, Alive in Christ." They refer to Paul the Apostle, Romans 6:11, which was also an inspiration for the dead theologians. Mount Carmel is also involved. Pope **John Paul II** called this "a new evangelization for the third millennium". The Catholic Church, i.e. the Mother Church the Dragon, wants to reinvent the ancient Osirian culture of death, the religion based on the Society of Jesus. There is more about this society on its webpage. More info at *Foundation Stone*, page 70.

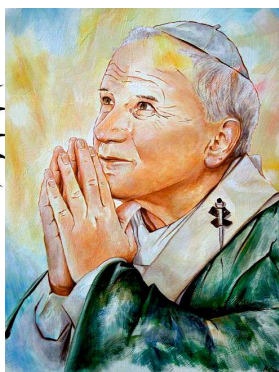

Pope John Paul II was, among other things, a Priest of Death



The Swedish royal family Bernadotte also belongs to Death



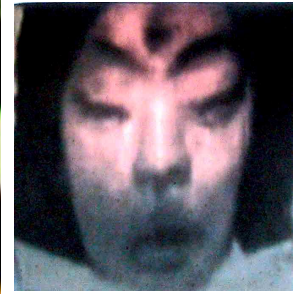

Inanna/Izates II/Jesus in the lunar module Phoenix on the far side of the Moon. Symbolically this means that she had the role of Phoenix throughout history. It was she that took all the kingdoms founded by Enki from him. This can prove that she still has this role against the Bull God, who also calls himself Phoenix. The goal is to eliminate Enki and take over his symbols, e.g. the Eagle and the seven-pointed star,

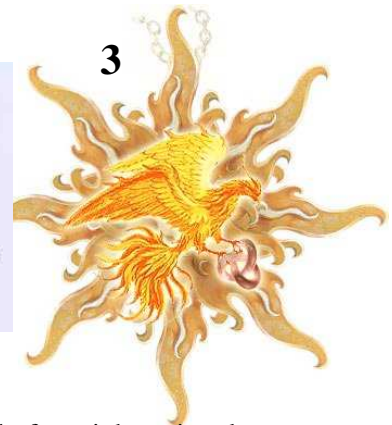
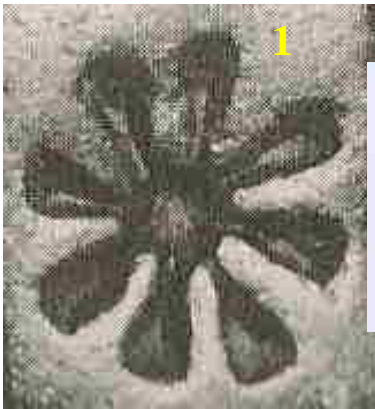

Inanna's and Izates' II/Jesus'/the Lamb's eight-pointed star, pict. 1 and 2. Pict. 3 is a symbol of an eight-pointed star, inside it is Phoenix. We can see that on Phoenix's head is a family tree, she always refers to this tree.

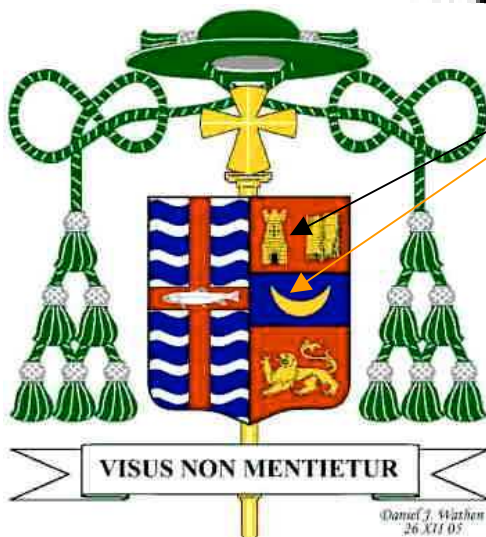

*Daniel J. Mathen  
26 XII 05*

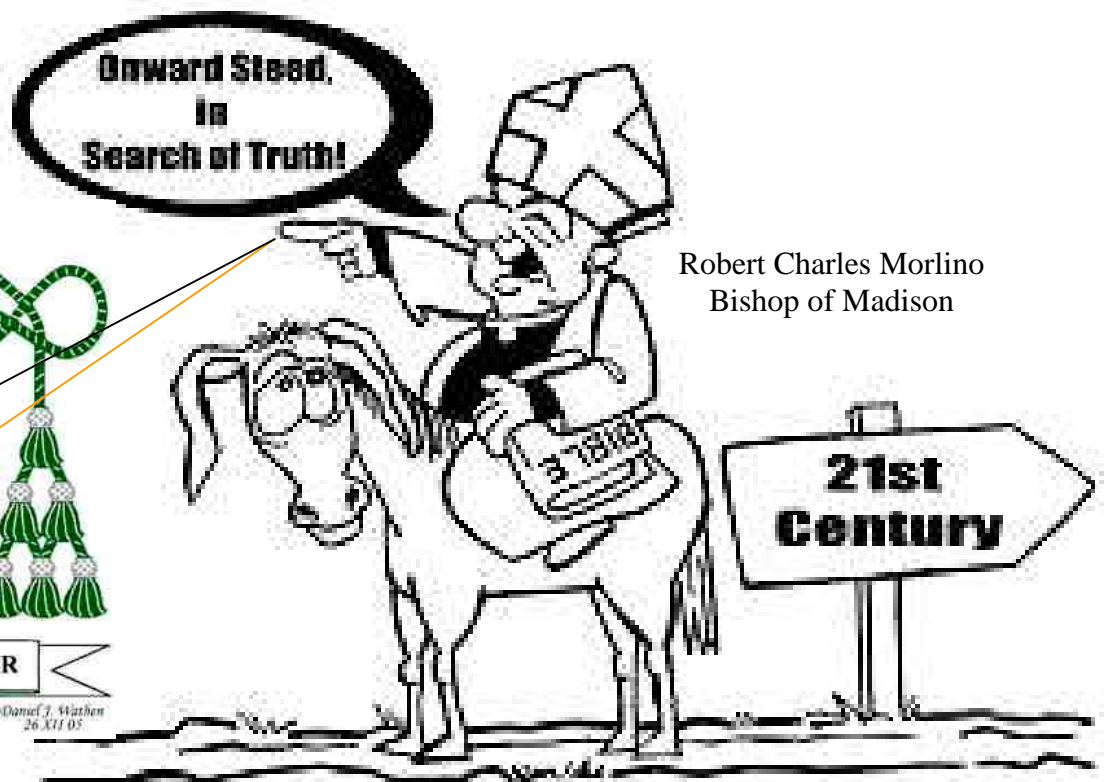

Robert Charles Morlino  
Bishop of Madison

*Wes Seeliger*



# Izsak crater and Izsak crater D

Now I will return to the Izsak crater and analyse in more detail what it means in this context, i.e. the context of Apollo 20 and its Moon mission.

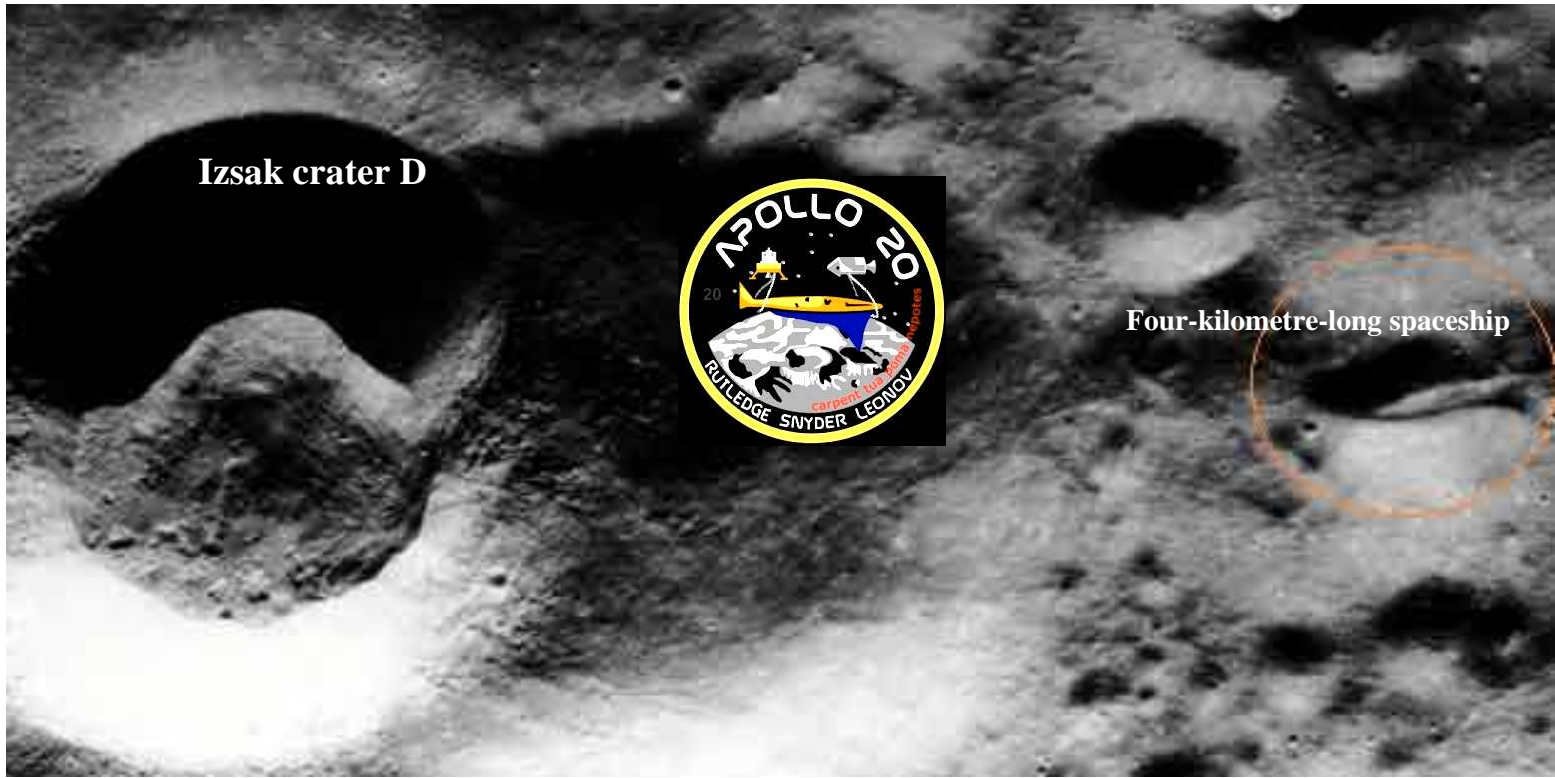

**Izsák, Imre Gyula**  
1929-1965



**Izsák, Imre Gyula**  
1929-1965

He was Hungarian, born in Hungary in 1929, in Zalaegerszeg, astronomer and scientist. He left Hungary in 1956 (together with hundreds of thousands of top-level Hungarians), ended up in Austria, eventually in the US, also worked for NASA. He died in Paris in 1965 during a conference. He was buried in Cambridge, Massachusetts (where he worked as an astronomer) on April 28. The double crater Izsak, west of Tsiolkovsky crater and Fermi was named after him. Let me return to the double crater Izsak on the far side of the Moon on the next page.





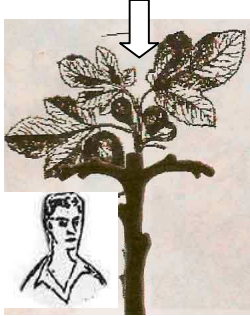

ADAM, Cosmic  
Adam's family tree

Izsak/Isaac is also a Biblical name. Abraham's younger son was called Isaac, according to the Bible. This name can also, symbolically, be connected to the Izsak crater. Over and over, the Serpent God was born into this family tree. I can add that the descendants of Benjamin turned up in Austria named Hiedler/Hitler and Reuben's descendants still exist today. Reuben himself was reincarnated and lived during the 19th century.

Brothers

ADAM/Enki, Earthly  
Adam's family branch

Terah



Abraham  
(Symbolic)



Abram



Ishmael (1)  
12 sons



Isaac/Izsak (2)

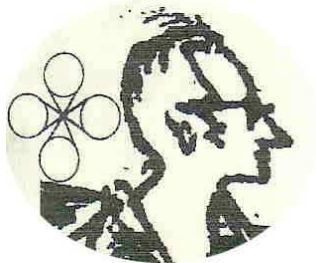

Abram's son



Esau (1)  
6 sons



Jacob (2)



Kemény  
1700-1800



Reuben (1)

Ruben, 1800

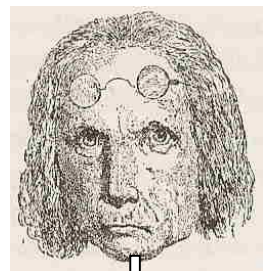

Benjamin (12)

Johann G. Hiedler  
1792-1857



We can see that the name Izsak also connects to the Bible and religion. An American ex-employee has claimed that the aliens in Area 51 mastered the Hungarian language. Bob Lazar's origin is Hungarian, too. What can all this mean, what was it that the aliens wanted to achieve with the Apollo-20 flight to the Moon?

A message to Earth with, in this case, Sumer as the point of origin. Besides Huluppu's family tree, the history of global religion started with Enki, Marduk, Inanna, and Gilgamesh. In those days there were terrible natural catastrophes on this planet. The Father of the Gods, An, and his adherents fled from Earth and chose planet Nibiru in the neutron star AN's solar system (more info at *Life and the Black Hole*, pp 6-8), while Inanna and her adherents chose the Moon for protection. Now you know who is hiding behind the symbol crescent/moon. Enki, Marduk and Gilgamesh and the rest of the family remained on Earth together with other peoples. Their protection was the Ark. The top-secret Apollo 20 lunar mission in 1976 confirms that Hungary was elevated to the centre of events in the history of the world. The Hungarian people, the Hungarian language, the Hungarian pagan culture are the foundations of this planet. In other words: Phoenix is a symbol of Hungary's past and today it is all about the battle between Inanna and Gilgamesh, a battle to conquer Hungary again, in the name of Christianity and for the sake of Gilgamesh.

I have previously mentioned that Hungary must leave the Holy See and the Christian religion to go back to the old Turul culture, founded by Enki-Árpád. More info at *The Fourth Pyramid which Disappeared*, pp 42-46 and 88-89.

There is a very interesting feature in Revelation, **Rev 14:1** and **14:4**. My view is that these 144,000 virgins/hybrids will be removed to the new Jerusalem which is already built on the far side of the Moon, where Phoenix touched down. More info at *Aries, Capricorn and the End of Time*, page 31.

There is also a new Jerusalem on planet Nibiru. Real men and women will be transferred there as far as I can understand. The town of **Jerusalem** was founded and built by David, a reincarnation of Marduk. Thus the town belongs to David and the Jews, as the nation Hungary belongs to Árpád and the Hungarian people. You cannot remove a founder regardless of time and religion, replace him with a different individual and rewrite history. This is something Hungary and Jerusalem in Israel have in common, as do Persia, the Roman Empire, the Aztecs/Mexico, and Egypt.



Yehuda bar Yehosef  
Son of Joseph Jr

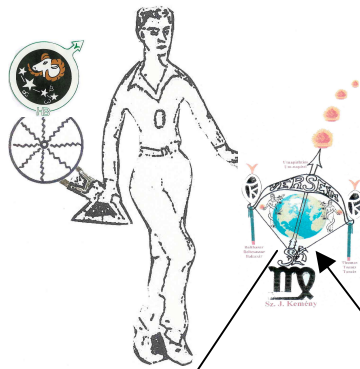

Yehosef bar Papos  
Joseph son of Papos  
Joseph Jr, foster-son of Joseph



Maria of Magdala  
Mary Magdalene



**Kenneth A. Arnold**  
**This was in 1947**

**Goal**



**16/08/1976, 23/08/1976**  
**This was in 1976**

There is one more important message from Apollo regarding Christianity: No Jesus/the Lamb was crucified in Jerusalem on Mount of Olives or the so-called Golgotha since his dead body was shown to the world from the lunar module Phoenix after around 2,000 years. This also proves he was not a Jew. He who was crucified died on the cross and was then buried in Jerusalem.

It is also one more piece of evidence in my father's paternity issue. The Lamb Christer R was not identical with the Lion Tibor E and the Bull was the biggest loser in this context thanks to the brutal, criminal contribution by the Swedish king. The entire Christianity thereby falls to pieces.

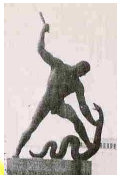

On page 95 at **Moon Mystery** I write this: "Long before the first landing on the Moon, American members of the UFO circles state their own explanation of the then ongoing space race."

The driving force behind the moon offensive was said to be something completely different from the official scientific aims. What stimulated both the US and the Soviet Union, according to this message, was the possibility that alien civilisations had built bases on the far side of the Moon. It must have been of utmost importance for both parties to become the first nation to establish contact with these advanced creatures, a goal which was kept from the general public. In retrospect we can see that the American UFO circles in the 1950's, 60's and 70's were absolutely right in their claim. This is further evidence that religion is on top of science and politics on this planet. Apollo 20 finished its lunar program with an excellent result, all I can do is congratulate. I claimed at *Moon Mystery* that NASA is a light in the dark and I will not abandon my point of view, it is still solid.



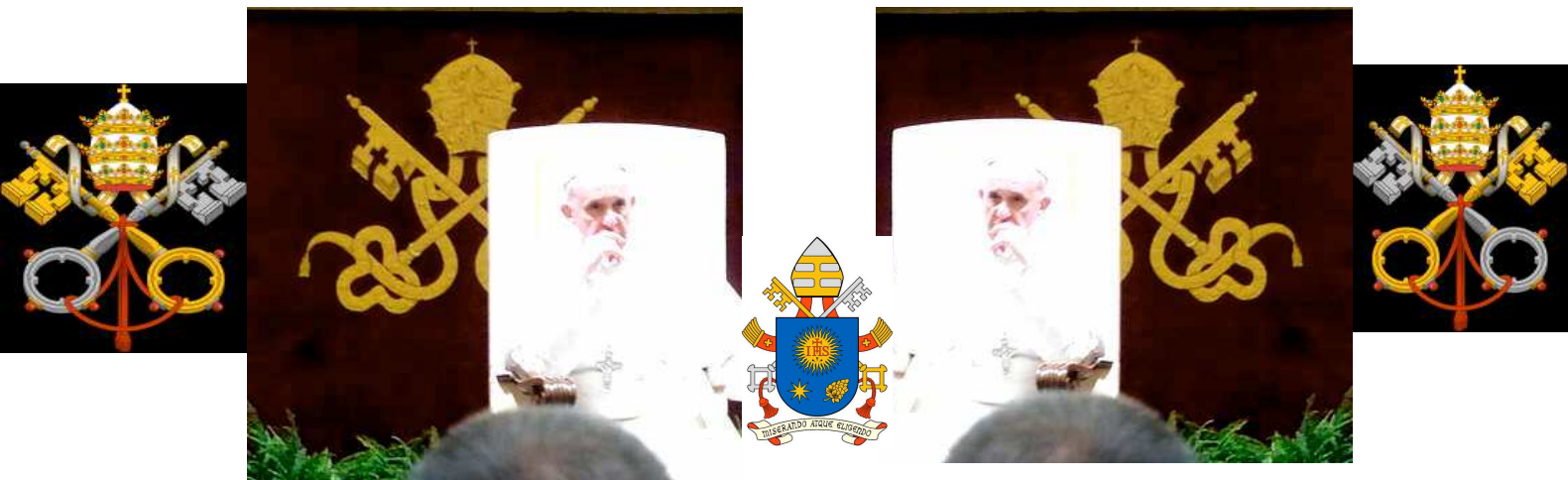

The new and last pope, Francis. Behind him the new Vatican coat of arms is clearly visible, two crossed golden keys. In this context, gold is a male representation, a male symbol of, among other things, the Sun and the Lion. The female silver key has disappeared and been replaced by a golden key. In other words; the Virgin, the Lamb, is gone.

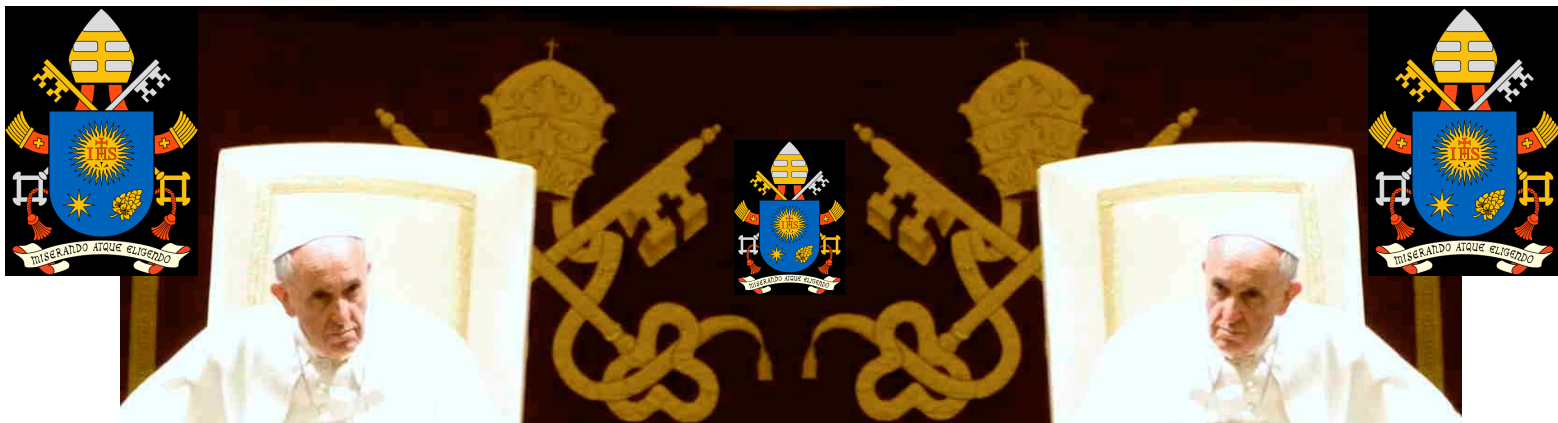

The Vatican coat of arms tells us very distinctly, that the Bull must now cross the path of the Lion, Tibor E, and take over his identity as a Lion, the Lion of Linköping/Judah. In reality, the Lion crossed the Bull's path via the Lamb and the Swedish king, the "higher horn." The featherbrained Bull has crushed Christianity, the boat is now filled with water.



A very concerned pope. It is not easy to take over a sinking fishing vessel, which is already almost totally submerged, filled with lies and blood. The vessel has not only caught human beings, the catch also contained large amounts of criminals, like the Swedish king and his mafia gang in the underworld, not only in Sweden. Pope Nicolas V warned his successors to be very careful with the paternity issue which is only about the Lion being replaced by the Lamb. It was to be solved in a human way: no violence, cheating or terror. The pope is ultimately responsible since he is the one who manages Catholicism from Rome, not the featherbrain the Stockholm Castle.

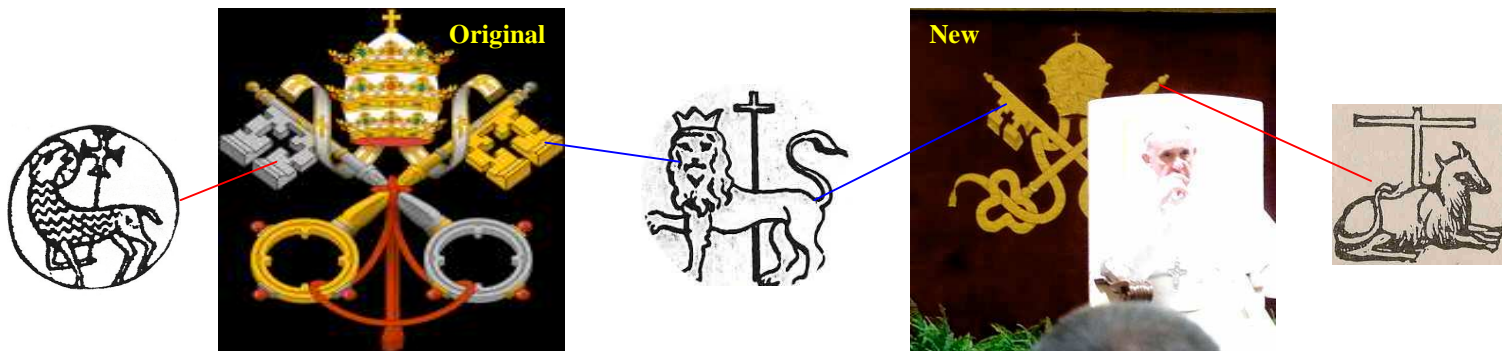

Officially, the original coat of arms of the Vatican state is still valid, but gradually the priesthood are carefully introducing the new coat of arms. This means that the ancient Osiris religion and death culture are added to the Christian program, according to Dead Theologians Society. The Catholic church in Palmar de Troya, Spain, has the same coat of arms two crossed golden keys and the papal tiara.





More info at *The Fourth Pyramid which Disappeared*, pp 57-58.

The gospels as well as Revelation and Gnosticism talk about the end of time as a period of terrible catastrophes. The Lamb Jesus told his disciples that the end of time cannot be avoided and that even Christianity will fall down. There will be wars which have never been seen on this planet. Strangely enough, Revelation does not mention Christianity or any other new religion. It is obvious that the Lion, the Lamb/Serpent and the Bull in the gospels are concentrated into one character called Jesus Christ, a character who has never existed. This saviour will never come, because he does not exist. The same goes for Carpenter, Jack-of-all-trades Joseph. He is no protector of the Christian religion. According to the gospels, Jesus killed the Fig tree/Joseph, he and his family's lives were destroyed and in the 1970's my father's and his family's lives were destroyed by, for example, cheating, fraud, violence and terror. How many popes have met my father? There were three women in those days: Jewess Mary, God's mother, the Greek Maria and Queen Helena. These three women melted together and formed Virgin Mary. God's mother, but she did not exist in this way. What is forgotten is that you cannot fool Nature if you are not familiar with its laws and rules. If you oppose Nature, you will eventually be eliminated. Religion is against Nature, the human nature, i.e. Nature became religion's enemy. We can summarise by stating that this religion, already at its beginnings, was sentenced to death, Pope Francis should know this. What is now important for Hungary is to turn its back to Christianity and the Vatican and return to the human nature, where focus is on Man and reunite with Árpád and Turul. After that many countries will follow Hungary's example. More info at *Obscure Magyar*.



Had my father and I known what was waiting for us and my family in Sweden, we would never have come here. We would have remained in Hungary or chosen another country in 1956, my father mentioned Germany as an example. I knew that I was going to write large, gigantic things but nobody, not even the priest (although he knew) had told me anything about what to write.- You never know anything at first, not until time is ripe. More info at *The Fourth Pyramid which Disappeared*, page 84.

Here I can add that I left my native country on October 6, 1964, exactly 50 years ago. The priest PP (who was a reincarnation of Pope **Nicolas V**) of the congregation where I was a choirboy, told me what was waiting for me in the future. The female teacher in the Swedish school told me exactly the same thing. In retrospect, 50 years afterwards, I can see that both the priest and the teacher were absolutely right.

See also *Autobiography*.



# The Jerusalem Cross

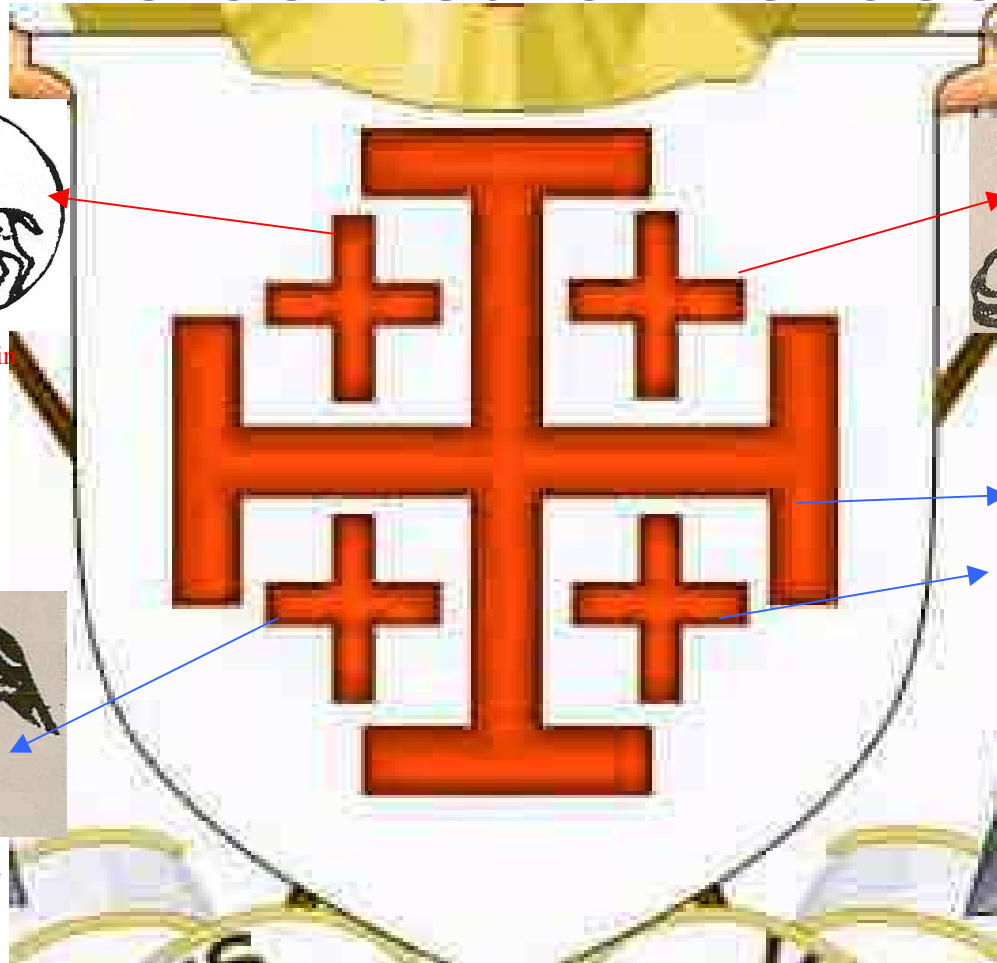

The Lamb/Serpent/Virgin  
Izates II/Jesus

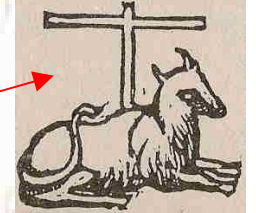

The Bull  
John/Mark/Jesus



The Lion of Judah  
David/Joseph jr

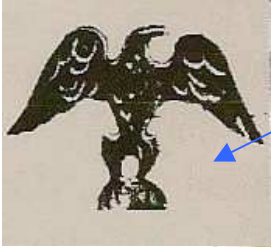

The Eagle, (Baptist) John  
(Julius Caesar)



My maternal grandfather

I can summarise thus: My paternal grandfather's father Mihály was an only-begotten son, my paternal grandfather Lajos had a brother, Simon. My father was also an only-begotten son, as am I. There is no third son, legitimate or illegitimate, my mother died in strange circumstances on January 13, 2007, but she never adopted a son. Little Tibor E was my father's only foster-child, there was nobody else then and there is nobody else today. Christer R is the only one who was born into my family, being Simon's grandchild. If the world in the nearest future will read that someone has found my father's, Tibor Kemény's unknown son, it is a lie, a fantasy fairytale, there has never been an unknown son. More info at *The Fourth Pyramid which Disappeared*, pp 60-61. I never had the opportunity to meet my maternal grandfather, he died before I was born. Some time ago I met him in a dream. He approached me smiling, gave me a hug, patted my left shoulder with his right hand and said this: "Get on with it, I'm behind you". By the way, my paternal grandfather Kemény Lajos and my maternal grandfather Hermann/Pálfalvi János were good friends in life. More info at *Obscure Magyar*, page 77.

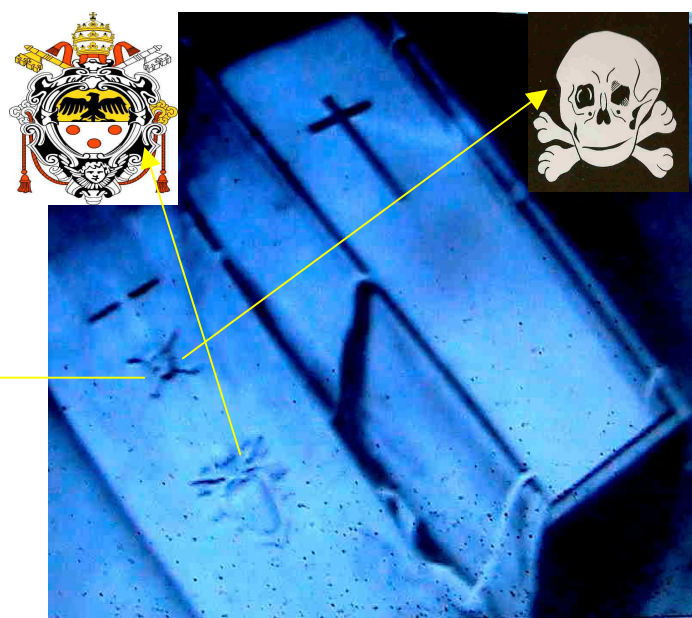
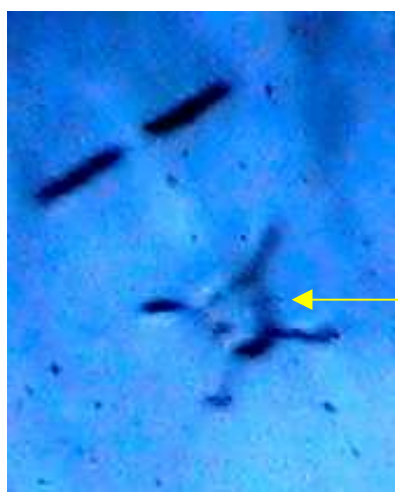

Pius XI, (1922-1939)  
261, 105 Intrepid Faith

Pope Pius XI's coffin. Above his personal coat of arms the skull is clearly visible, a symbol of death. A beam of light shaped like a cross points at the skull. **Rev. 1:17-18. Death and the keys of Death.** The Holy See is at the centre of Christianity and a tool of death.



# Pontificate Duration



**Pope Pius IX, (1846–1878), 32 years**  
257, 101 Cross from Cross

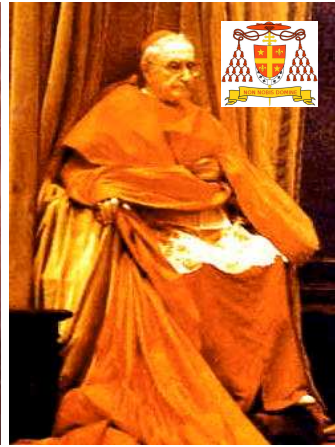

Cardinal Giuseppe Siri, elected pope 1958, 1958-1989  
**Pope Gregory XVII, 31 years.**



**Antipope Gregory XVII, (1978-2005), 27 years, Palmar de Troya**  
Antipope from August 6, 1978



**Pope John Paul II (1978–2005), 27 years**  
266, 110 From a Solar Eclipse  
Pope from October 16, 1978

We can see that the "pontificate world record" so far is held by pope **Pius IX**, he was a pope for 32 years. Close behind him is Pope **Gregory XVII**, 31 years. Antipope Gregory XVII is on third place with his 27 years and the fourth is so far Pope John Paul with his 27 years. Only a few months keep the pontificates of Gregory XVII and John Paul II apart. More info at *The Fourth Pyramid which Disappeared*, pp 58-59.

## The Roman Catholic Church is the cradle of Christianity

### Popes and antipopes between the Earth and the Moon



Rome, The Vatican, Italy



Palmar de Troya, Sevilla, Spain

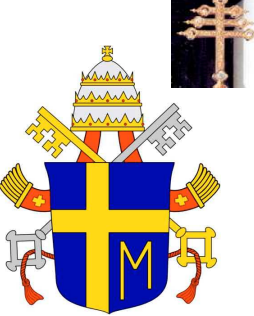
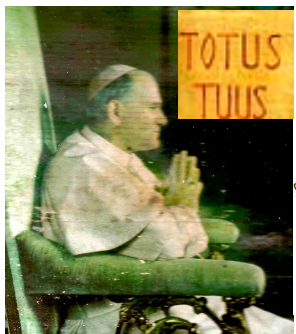

**Pope John Paul II (1978–2005), 27 years**  
266, 110 From a Solar Eclipse  
(The Lamb – the Bull)



**Pope Benedict XVI, (2005–2013)**  
267, 111 Glory of the Olive.  
(The Lamb)



**Pope Francis I, (2013-2018)**  
268 112, Petrus Romanus  
(The Bull)



**Antipope Gregory XVII, (1978-2005), 27 years**  
Palmar de Troya, (The Bull)

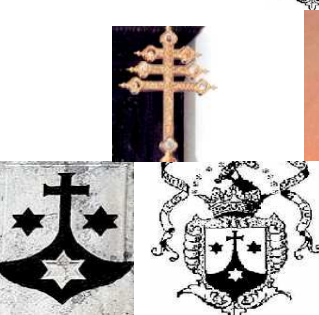

**Antipope Peter II, (2005-2011) Palmar de Troya, (The Bull)**



**Antipope Gregory XVIII, (2011-2012) Palmar de Troya, (The Bull)**



# Origins



Kemény Tibor, 1943 Budapest



The Lion of Judah Josef Jr

A sculpture of Joseph Jr. from Nazareth was found in the **mid-1970's in Jerash in Palestine**. Experts regard this as the oldest stone Messiah picture ever carried out. We can give the thought closer consideration, writes the paper, and consider it as a work of art by some artist who lived at the same time as the Nazarene. It was he who was crucified in Jerusalem and was buried there the same day. A possible artist could be the jack-of-all-trades, Carpenter Joseph himself (he was also a sculptor) or his daughter. I can add that my father Tibor Kemény was a jack-of-all-trades. Among other things, he studied of sculpture to at the Academy of Arts in Budapest at the beginning of the 1940's. My sister Emöke Kemény studied to become a painter at the end of the 1960's here in Stockholm. The sculpture portrays a Jew, around 40-55 years old. More info at *Tutankhamun, the Young Lion* and *Omnipotent Akhenaten*, pp 14 and 17. – He was the foster child of the jack-of-all-trades, Carpenter Joseph.



The Lion of Judah Josef Jr



Jack-of-all-Trades, Carpenter Joseph



The Lamb Izates II/Jesus

The origin of this part of a head is Izates II/Jesus. The body was found in Phoenix, the American lunar module in August, 1976, on the far side of the Moon. The picture can confirm that no Jesus was crucified and buried in Jerusalem in those days. Neither was anyone resurrected from the dead. The picture shows that neither was he a Jew and could have been between 40 and 50 years old. He also wanted the truth to be told also in this context. He took over the identity of the Jew, Joseph Jr. and called himself Son of Man, i.e. son of the jack-of-all-trades, Carpenter Joseph. He was a relative of Joseph's.



The Lamb Izates II/Jesus



The Bull Marcus Jesus

There are no contemporary pictures or sculptures of John/Mark whose origins were Greek. There is nothing, compared to Joseph Jr. and Izates/Jesus, about his personality which can lead us back to the origins. There are only fantasy pictures which look different. He was the one who was born after the death of Herod the Great into a very rich family connected to the Herod royal family, also of Greek origins. After this super-rich character, time is divided into before and after Christ. Nostradamus, Christianity, the gospels and history describe him as Antichrist. He also appears in the gospels as Jesus and is focused into three individuals who have never existed. In the gospels there are several lies about him, but not the truth. He also claimed that he was the son of the jack-of-all-trades, Carpenter Joseph.



The Bull Marcus Jesus



We say that history repeats itself



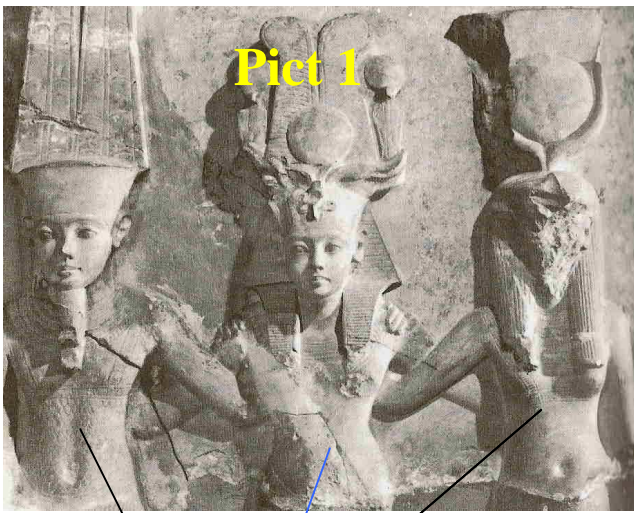

Amun, Tutankhamun  
Dynasty 18 Mut



Amun, Ramses II  
Dynasty 19 Mut

Akhenaten of Dynasty 18 abolished the Amun cult and did not even want to hear about it. In those days it was all about Aten, i.e. the Serpent itself..

A short look back at ancient Egypt, at Dynasty 18 and 19. Pict. 1, Dynasti 18, is an illustration of the young Lion, Tutankhamun, a reincarnation of, among others, Khonsu, Amun's foster child. He is between his mother Mut and Amun. Pict. 2, Dynasty 19, shows the Bull deity Ramses II/Osiris sitting between Amun and Mut. The Bull deity claimed that he was the son of Amun and Mut and removed the Lion king Tutankhamun.

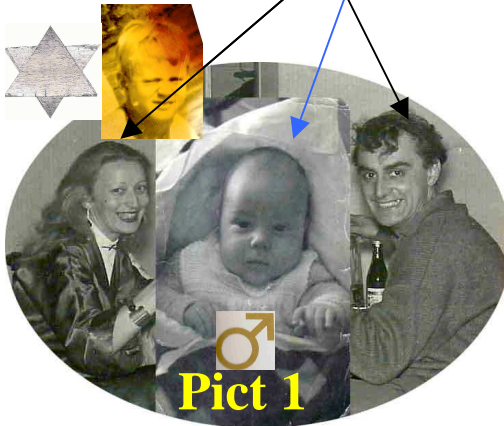

Pict 1

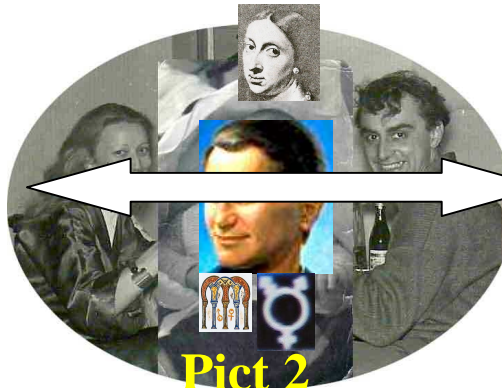

Pict 2

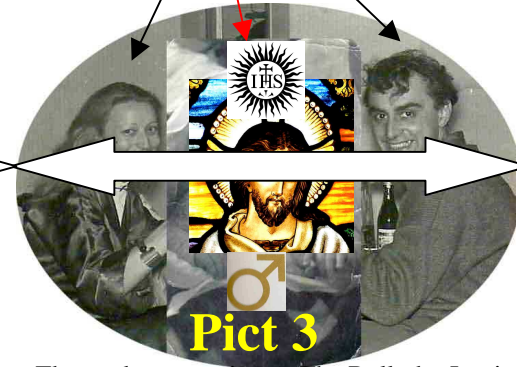

Pict 3

Christmas Eve 1958, Linköping My father Tibor Kemény, Jewess Maria E and the newly-born boy Tibor E who was my father's foster child. **The Lion Tibor E, 1958-1971**

The child of my father's cousins, Christer R, replaced the murdered Tibor E and took over his identity. This happened during my father's life, he declared that he had nothing to do with this Christer R. Christer R is a reincarnation of, among others, the Virgin, Queen Christina. **The Lamb/Serpent Christer R, 1971-2007**

The madness continues. The Bull, the Jesuit, one of the world's wealthiest men, removed Christer R 16 years after my father's death. Now he is in the secret world instead of the murdered Tibor E who was thrown into an old grave wrapped in a black plastic bag at the Catholic cemetery in Solna, spring 2012. **The Bull, the Jesuit 2007.**

A short look back at Sumer, where we find the jack-of-all-trades Carpenter Huluppu and his family: Marduk the Lion (Tibor E), his biological parents Enki (vitéz Kemény Simon), and Ninhursag (Jewess Maria E.), the Serpent/Dragon Tiamat/Inanna (Christer R) and the Bull Gilgamesh (The Jesuit). More info at *Obscure Magyar*, pp 1-8. We can clearly see that my father's paternity issue reflects not only ancient Palestine/Judea/Jerusalem but also ancient Egypt and Sumer.

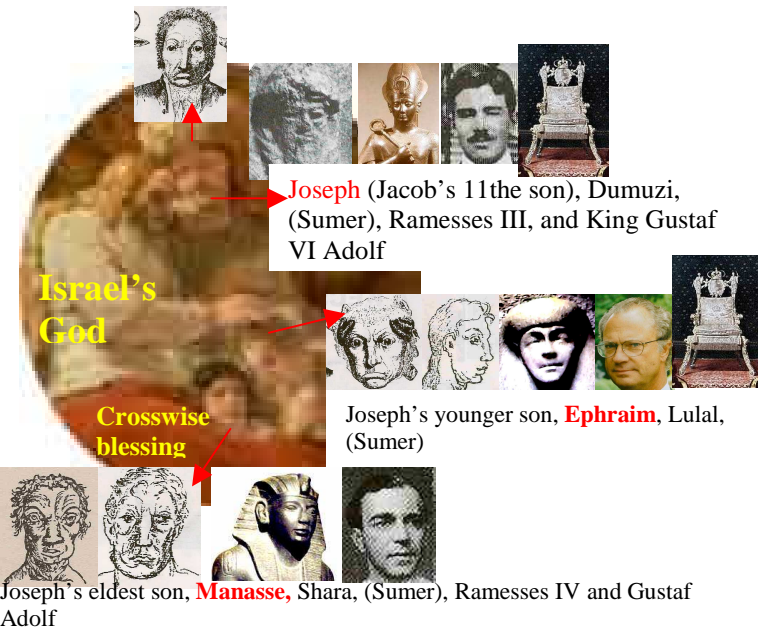

Joseph (Jacob's 11th son), Dumuzi, (Sumer), Ramses III, and King Gustaf VI Adolf

Israel's God

Crosswise blessing

Joseph's younger son, Ephraim, Lulal, (Sumer)

Joseph's eldest son, Manasse, Shara, (Sumer), Ramses IV and Gustaf Adolf

This painting is an illustration of how God gives a crosswise blessing to Joseph's sons Manasse and Ephraim, a symbolic gesture implying that they will meet in the future at an episode in ancient Egypt, Dynasty 20, in connection with the murder of Pharaoh Ramses III. Prince Pentawer was involved to remove his elder brother Crown Prince Ramses from power. This is the first time we see a so-called crosswise blessing of two brothers, their roads will meet. One could as Ramses IV ascend the throne after their father Ramses III, the other brother committed suicide in a prison, Prince Pentawer. Pentawer's mummy is preserved in Cairo. As early as in 1886 Gaston Maspero examined the mummy and signs indicated that it was Prince Pentawer. On **April 30, 1984**, the mummy was examined again and on **April 30, 2008**, at 9.18 a.m., the identity was confirmed: Prince Pentawer, son of Ramses III. **April 30** is an important date, on **April 30, 1945**, Gustav Hitler, who took over his brother Adolf's identity, was pronounced dead and on **April 30, 1946**, Carl XVI Gustav Bernadotte was born in Stockholm. Dynasty 20 ended with Pharaoh Ramses XI, who was a reincarnation of Prince Pentawer. More info at *The Fourth Pyramid which Disappeared*, pp 19 and 20.



The next time we meet Prince Pentawer/Ramesses XI is in Babylonia, he is King Belshazzar in Daniel's time. King Belshazzar was the king who finished the Babylonian monarchy. Now, at the end of time, we find the same crosswise blessing in the Bernadotte royal family. Gustav Hitler was pronounced dead on April 30, 1945, and the year after that King Carl XVI Gustaf was born on April 30 in Stockholm. The then head of state, King Gustaf VI Adolf's son was crown prince, not the newborn son. The then crown prince Gustaf Adolf was born on April 22, 1906. It is said that that he was a fairly wise and meditative person. He would probably never have accepted the assignment from the pope to kill an innocent 12-year-old boy, well known within my family circles, and replace him by a much older relative who we had never seen before in those days, at the beginning of the 1970's. Pope Pius XII knew exactly who Crown Prince Gustaf Adolf was and had him killed. On January 26, 1947, Gustaf Adolf was killed at Kastrup airport in Copenhagen. The accident was a conscious and well thought-through sabotage directed against the crown prince. His road intersected that of his son's, Carl Gustav, who in the 1970's in secrecy took over the Lamb's private issues. Crosswise blessing here means killing one of them. Pope Pius XII knew exactly who was born on April 30, 1946 and allowed him to live. Each time you are reincarnated you do almost the same things as in an earlier life, the Holy See knew this. The last discussion with Pius XII, before he died, was about a dark vision of the Church and the world.

The pictures below illustrate that the Church has a secret door leading to a different reality, a reality which can only be crossed by the current pope. The invisible door was and is my father's secret paternity issue, without a valid acknowledgement of fatherhood. The pope could have opened if he had allowed my paternal grandfather's younger brother, vitéz Kemény Simon, Raoul Wallenberg and Crown Prince Gustaf Adolf to live. Then this situation would never have occurred, the Church and the Christian religion would not have fallen apart.



På bilderna visar påven Pius XII sin mörka vision om kyrkan och värden i dödens skugga

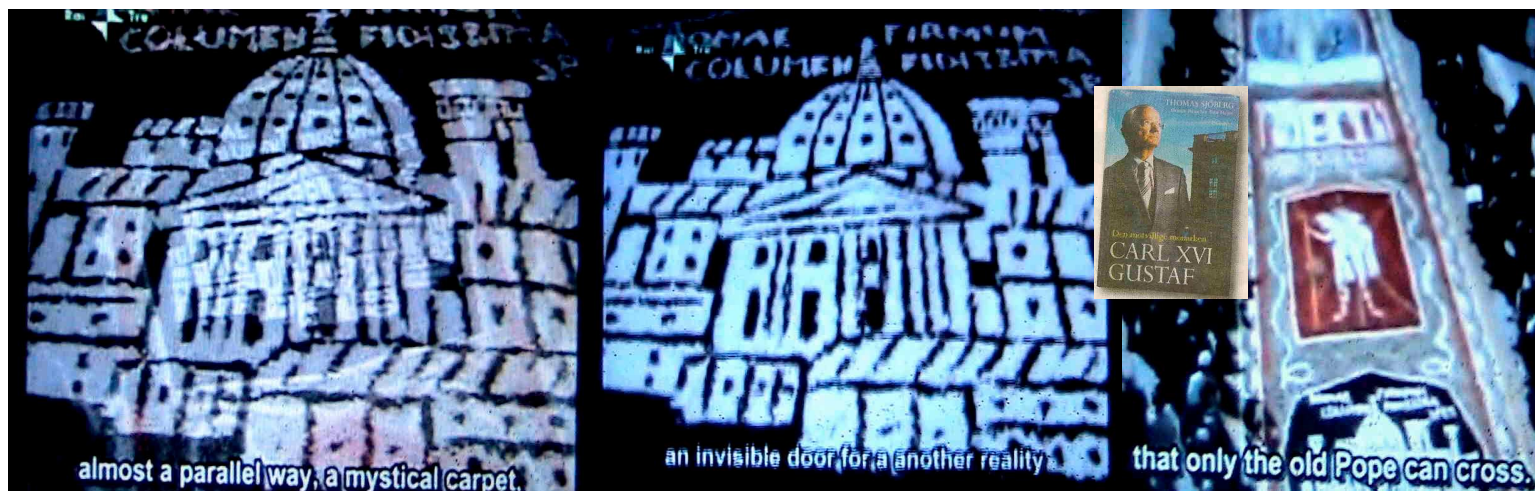

But Pope Pius XII chose the blood-stained, dirty road by killing important persons. The question is: Who could possible have accepted the papal assignment during the 1970's? The choice was made as early as in Jacob's time, when Israel's God, the Serpent, crosswise blessed Joseph's sons Manasse and Ephraim. He elevated Ephraim as number one and placed Manasse, Joseph's first-born, behind him. When the Serpent/Lamb Gustav Hitler was declared dead on April 30, 1945 he gave a sign and next year Ephraim was reincarnated as Carl Gustav, on April 30, 1946 in the zodiac sign of Taurus in Stockholm. In 1973 he ascended the throne of the Virgin/Serpent Christina, taking the name Carl XVI Gustaf. When the last discussion with the pope took place in October, 1958, the pope knew exactly the result of my father's paternity issue. Involved were the Lion Tibor E and the Lamb/Serpent Christer R during the 1970's and finally the rich Bull and the Jesuit during 2007, 16 years after the death of my father. The pope's vision of the future Church and the world therefore became very dark and the present pope, Francis, can confirm this. From the start they knew that the Christian religion (in connection with my father's paternity issue) would perish. Nostradamus, St Malachy and several others had written about this. The king is specially elected from the Bernadotte royal family, he tore the whole issue into rags including the Christian religion. He was rewarded by a life in luxury, wealth, limitless criminality, no laws nor rules in the wild west of the mafia.

The saddest loser in this context is the Bull, the Jesuit, we have nothing at all to do with him. He does not even belong to my family, the king and the arch bishop should allow my father to rest in peace now. Enough with madness.

My family and my family tree were hurt by all this and, indirectly, the following countries are squeezed between the Kingdom of Sweden and the Vatican: Hungary, France, Germany, and Italy. Biologically affected are Hungary (because in this issue we were all Hungarians when my father lived), Germany (because my maternal grandfather was a German), and Croatia (my paternal grandfather's mother was a Croatian). As the head of state and king he is a gigantic disgrace before honest Swedes and before the nation. He is also a disgrace before the monarchy, especially in Europe. The latest book about him is **Den motvillige monarken** (The Reluctant Monarch). From it we learn about his parties, his women and his mafia connections. This all goes back to Pentawer/Ramesses XI and Dynasty 20 in Egypt and Babylonia with King Belshazzar at the time of Daniel. Honest Swedes have to change into a republic as soon as possible and leave the Church and religion behind.



The human blood is what is most important and most valuable in life. We cannot walk the roads of life without human blood, without being a human being. On the road of life we cannot bring tanks, rockets, aircraft, missiles, nuclear bombs, money, wealth, etc. Try to become human again, continue the blood transformation experiment. Maybe someone will be lucky and manage to become a human being. Then we will not need violence, cheating and terror to enter the Road of Life, trying to steal my family tree.



Finally,  
**A Thank you to my good Father, Tibor!**

My good father! First I will say to you that what you entrusted to me I have accomplished. I want to thank you for your trust given to me by you and our family tree and that the majority of our galaxy's guardians approved. The world now knows that you are a Human Being and at the same time, to the highest degree, Son of Man. You are good and helpful and you helped others as much as you could, for example the farmers of Kalocsa during Communism at the beginning of the 1950's. Despite the fact that grandfather was outspoken, as was Simon, the communists never attacked our family. As I have already mentioned, you made one single mistake in your life, when you chose the Kingdom of Sweden in Linz in 1956. But I also know that fate wanted that, so it was impossible to avoid. The Swedish representative told the refugees in Linz that Sweden was a monarchy and the royal family Bernadotte was a human family working for humanity. This influenced you when you took the decision in Linz and you lived the rest of your life here in Stockholm, you met this human royal family at a distance.

This royal family Bernadotte was and still is a catastrophe for us, for our family tree, for humanity and for Sweden as a nation. I am sure you remember the 70's, when the royal family attacked us with, among other things, violence, terror and forged documents. We said that the old "Ephraim" and his criminal gang had attacked again." This dark, evil, featherbrained monster stated that you were the father of Christer R. the Lamb and referred to an invalid document which you were tricked into signing in 1958 in Linköping. This document has no information about who was born. The gender and identity of this newly born baby boy were missing, you know that. I remember well, my good father, that you did not even get the opportunity to defend yourself in this human Kingdom, everything you wrote about the false accusations was rejected. Instead, this animal used violence and terror against you and us. He totally humiliated you and us. Police and the office of the public prosecutor were silenced and this animal did whatever he liked with the forged cards of the crimes. In that way he ended the Christian religion which is of no concern to us. After your death in 1992, Christer R., the adult children of your cousins, has relinquished their part of the inheritance in a forged letter. You know that he did not know anything about yours and my existence. Yet he took part in the estate inventory. One evening a woman called me, her voice resembled Maria's, she wanted to tell me something. She started with "I am..." then she was disconnected. It seems as if she was silenced. Everything I wrote about the estate inventory was rejected, I had to enclose the forged letter and also documents concerning the change of identity. During the leadership of this animal the situation was the same as before, maybe a bit worse. I can compare it to "artificial respiration" since another animal, the Bull, wanted to remove Christer R. the Lamb and adopt his forged documents in connection with the birth of little Tibor.

Now we write 2014 and the last pope in place, at the center of death. At the same time, the king is starting to feel the heat. In the future in Sweden he will be called **CARL GUSTAF THE LAST**. This royal family has nothing to do with humanity and democracy, they have a qualified military education, are pro-war and the tools of death. When his daughter married in 2010, **18 jet fighters** were seen above the castle and the references to war were noticeable. It was a hidden and symbolic message, a demonstration that the royal family is still against you and us. They could have chosen 17 or 19 fighters, but the king chose **18**, which is your number, your birthday. He continues with the church in the same false ways and I continue with the same strategy we used in the 70's. One thing is crystal clear: I was, I am and I will always remain your only-begotten son. Nobody can take this away from me, the primogeniture in our family tree. It is the blood, the human blood which counts, religion must at last accept this. A small piece of land under my foot and extensive knowledge is good enough for me when it comes to defending and representing our family tree against those who attack us with false statements about violence and terror. My good father, you know I come from your flesh and blood, I will follow you on our way into the future, into Life, into the future of the eternal, long journey. I hope the people who accompany us will experience a real, human world which you will stand up for. My good father, the happiest moment of my life was when I, at the Central Station in Stockholm in 1964, could hug you after eight long years. The next happy moment will come when I hug you and our family again, when all four of us reunite. My good father, I do not say goodbye, I only say "We'll meet again!!!" Your beloved, only-begotten son and heir, Szabi. -Szabolcs Iózsef/Josef.

See also  
*Autobiography.*

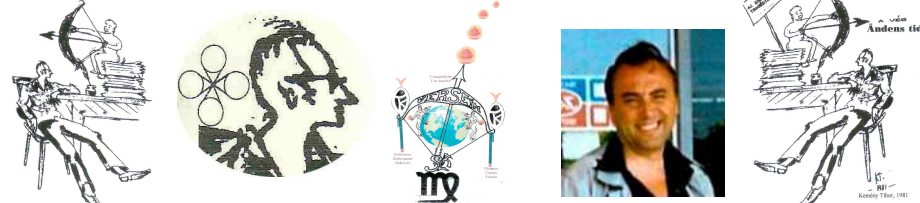

See also  
*Autobiography.*



# Nostradamus' Prophecies

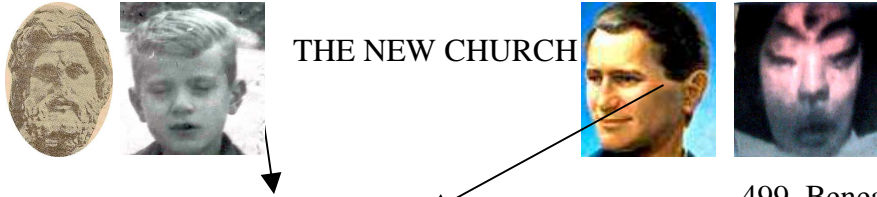

THE NEW CHURCH

494. The law of the Sun and of Venus in strife,  
Appropriating the spirit of prophecy:  
Neither the one nor the other will be understood,  
The law of the great Messiah will hold through the Sun.

495. The great mountain, seven stadia round,  
after peace, war, famine, flooding.  
It will spread far, drowning great countries,  
even antiquities and their might foundations.

496. The Holy Empire will come into Germany,  
The Ishmaelites will find open places:  
The asses will want also Carmania,  
The supporters all covered by earth

497. A new sect of Philosophers  
Despising death, gold, honors and riches  
Will not be bordering upon the German mountains:  
To follow them they will have power and crowds.

498. Beside the young one the old angel falls,  
and will come to rise above him at the end;  
ten years equal to most the old one falls again,  
of three two and one, the eighth seraphin.

499. Beneath the holy earth of a soul the faint voice heard,  
Human flame seen to shine as divine:  
It will cause the earth to be stained with the blood of the monks,  
And to destroy the holy temples for the impure ones.

500. Temples consecrated in the original Roman manner,  
They will reject the excess foundations,  
Taking their first and humane laws,  
Chasing, though not entirely, the cult of saints.

501- Then the holy splendor will lower its wing  
The Great One comes, who will give us law  
When low grows high and impudent is punished  
and none like Him the Earth will see



**The New Church.** Pope John XXIII is chiefly known for having summoned the Second Vatican Council (1962-1965), also called the New Church or the renewal of the old church.

Quatrains 494 to 501 are about the events at the end of time, where Sun acknowledges the right of Messiah against Venus. **Rev. 5:5-6.** "The Victorious Lion of Judah." The Sun is a symbol of the Lion, and Venus is referred to Revelation, the Lamb/Virgin/Morning Star. In other words: the Jews are acquitted of all accusations and nobody has the right to accuse them of crimes they have not committed (I hope the Romans will also be free from being inhumanly persecuted all over the world). We clearly see from the quatrain that the meaning of religion is not understood. The actual final goal of religion cannot be understood in this context, not even science can grasp it. The Nobel Prize, its blood-stained money and laureates have no idea either about the whole Universe in which we exist, according to Nostradamus.

Quatrain **498** mentions the mission of the eighth seraph. This coincides with The Royal Order of the Seraphim which is placed into an eight-pointed star. The foundation is to be found in the Catholic church, the so-called Society of Jesus. More info at *The Fourth Pyramid which Disappeared*, pages 87-88, which describe the fall of Christianity and the church.

In quatrain **500** Carpenter Joseph's paternity issue in Palestine (Bethlehem, Nazareth, Jerusalem) coincides with my father Tibor Kemény's paternity issue in Sweden (Linköping, Stockholm). This reflects Palestine and Rome. More info at Foundation Stone, pp 31 and 72.



With quatrain 501 finishes his prophecies regarding the new church. Laws in question are natural laws and rules, i.e. nature's laws governing our galaxy. More info at *The Secret of the Black Hole, What Happens in a Black Hole, Voyage Through the Black Hole, Life and the Black Hole, The Struggle for the Kingdom of Death, and The Maya Calendar and Omega*. In other words: What makes the very best to the most noble and the most noble to the very last?

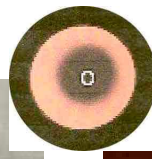
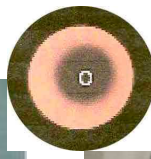
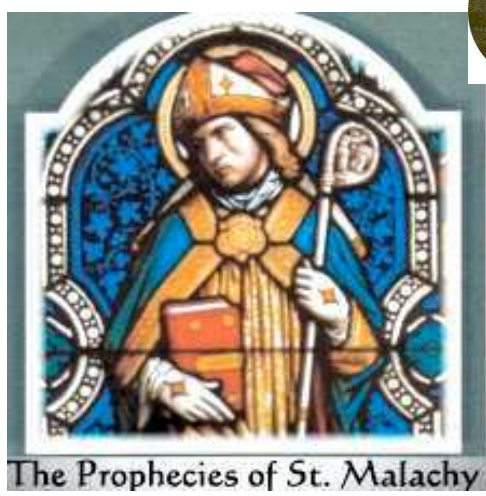

**Kemény Lajos**  
My good grandfather



**Nostradamus profetior**



**My good Father**  
**Kemény, Tibor István, 1923-1991**

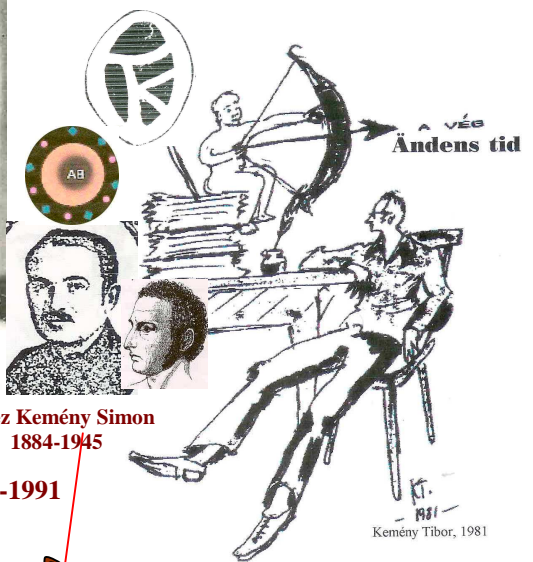

**Sz. J. Kemény**

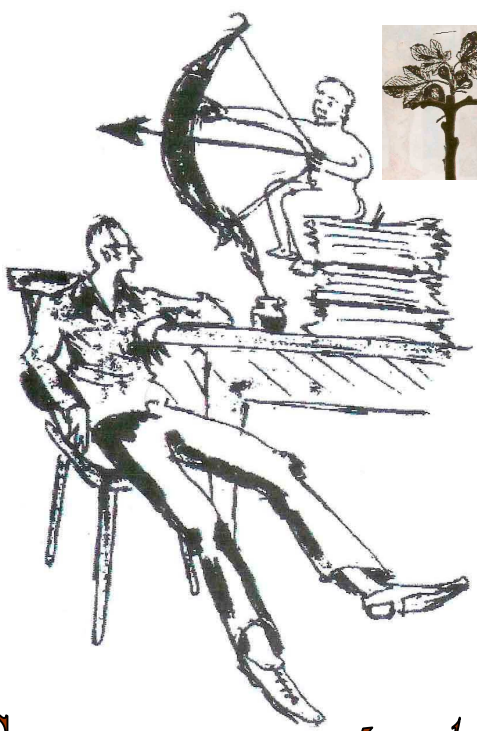

**Sz. J. Kemény**

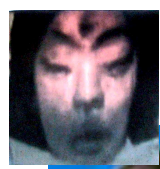

**R. Christer, (1948-)**  
My Father's cousins' child  
Son of Helena.  
To around 2007



**The Jesuit, (1946-)**  
From around 2007-

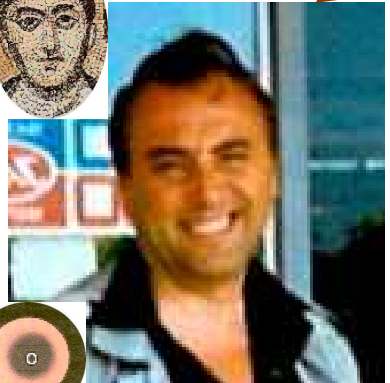

**Kemény, Szabolcs József (Josef), 1949**  
Only-begotten son and heir  
of my Father



**E. Tibor, (1958-1971)**  
Only-begotten son of Jewess E. Maria  
Foster-son of my Father  
Kemény Tibor

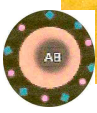
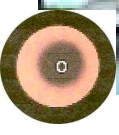



Daniel 12:4 and 12:13

“But you, Daniel, shut up the words, and seal the book until the time of the end; many shall run to and fro, and knowledge shall increase.”

“But you, go *your way* till the end; for you shall rest, and will arise to your inheritance at the end of the days.”

# The End of Time

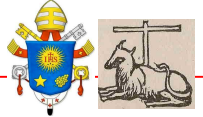

Finally:

5, Jesus said, "Know what is in front of your face, and what is hidden from you will be disclosed to you. For there is nothing hidden that will not be revealed. And there is nothing buried that will not be raised." Jesus, too, wanted to reveal all that is secret and give knowledge to the world. 10. Jesus said, "I have cast fire upon the world, and look, I'm guarding it until it blazes." 16. Jesus said, "Perhaps people think that I have come to cast peace upon the world. They do not know that I have come to cast conflicts upon the earth: fire, sword, war."

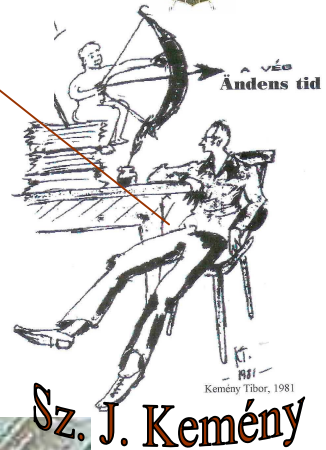
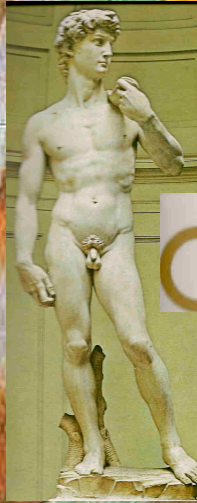
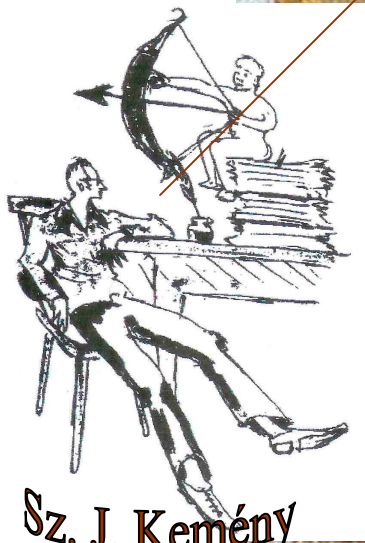
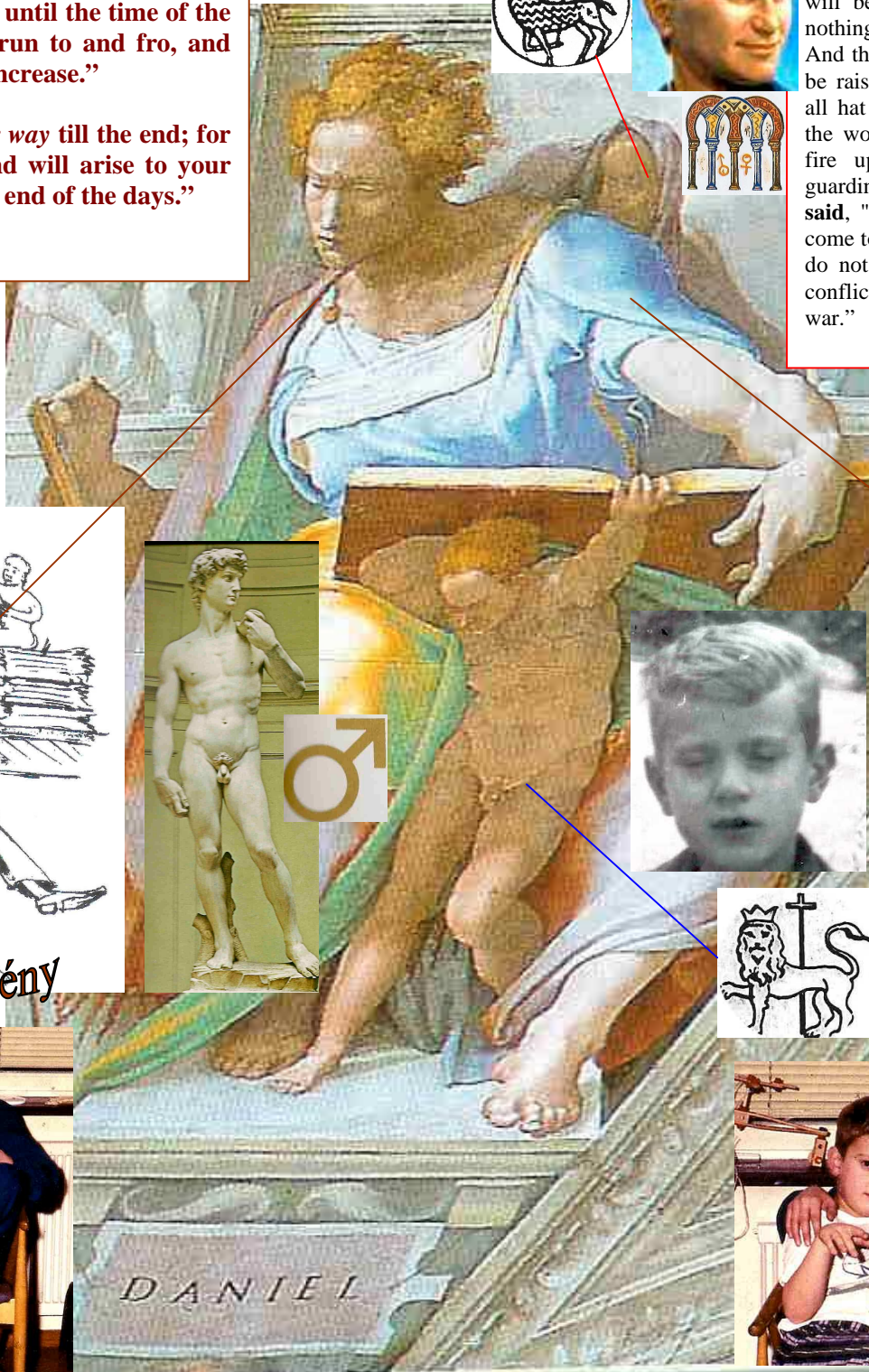

Tibor E and I, Szabolcs Josef  
Photo: Tibor Kemény 1964  
Stockholm

Michelangelo, Daniel, Sistine Chapel,  
Rome, 1511



Tibor E and I, Szabolcs Josef  
Photo: Tibor Kemény 1964  
Stockholm

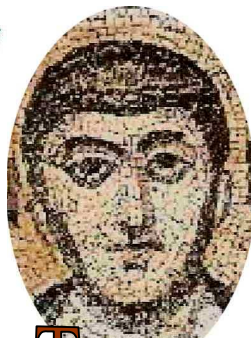
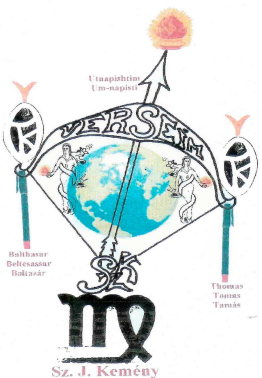

Thomas, Tomas, Tamás

